

PRODUCT
CATALOG

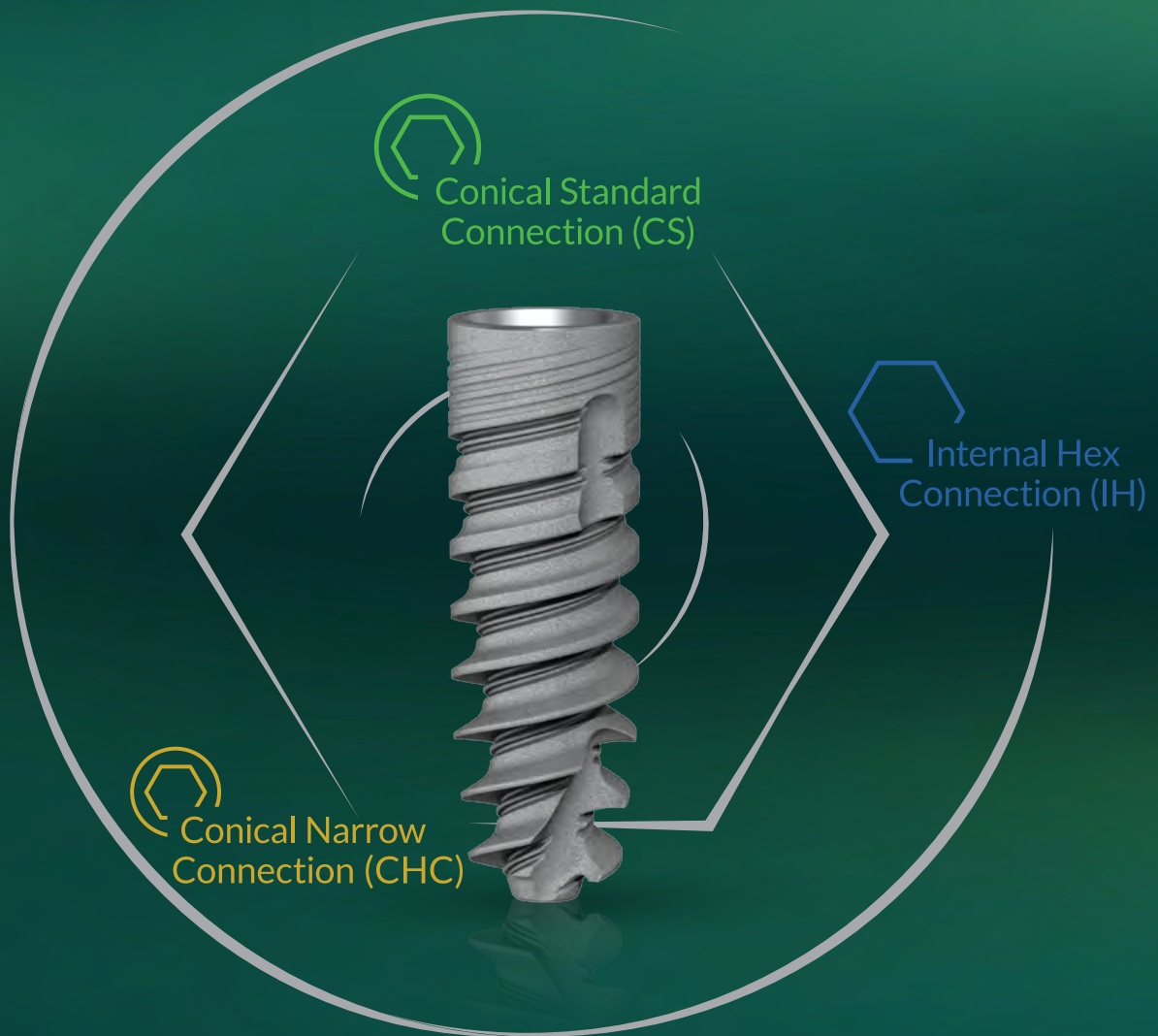



MULTI**neO**[™]

ONE IMPLANT **MULTIPLE OPTIONS**

The MultiNeO[™] implant is based on over three decades of proven clinical studies & experience and it is a direct derivative of the company's mission to provide high quality, innovative, simple to use products.

For more information on the MultiNeO implant system, refer to the following sections:

MultiNeO Implant Internal Hex Connection- Page 30

MultiNeO Implant Conical Narrow Connection- Page 61

MultiNeO Implant Conical Standard Connection- Page 81



TABLE OF CONTENTS

Introduction

SIMPLANTOLOGY, IN EVERYTHING WE DO!	6
SMART IMPLANTOLOGY SOLUTIONS - OUR PORTFOLIO	8
NANOTEC IMPLANT SURFACE	12
ADVANCED IMPLANT PACKAGE	13

Kits and Drills

SURGICAL KITS	16
GUIDED SURGERY TOOL KIT (GSTK)	18
STOPPER KIT	20
SURGICAL DRILLS AND TREPHINES	21
COATED DRILL LINE	22
IMPLANT INSERTION TOOLS	24
SURGICAL ACCESSORIES	26
PROSTHETIC INSERTION TOOLS	27

Internal Hex Connection (IH)

Implants

MULTINEO IH IMPLANT	30
MULTINEO IH DRILLING SEQUENCE	32
ICE IMPLANT	34
ICE DRILLING SEQUENCE	36
SPIRAL IMPLANT	38
SPIRAL DRILLING SEQUENCE	40
DFI IMPLANT	42
DFI DRILLING SEQUENCE	42

Prosthetic Line (IH)

HEALING ABUTMENTS	44
IMPLANT IMPRESSION	46
CEMENT-RETAINED RESTORATIONS	48
TEMPORARY PEEK ABUTMENTS	50
TEMPORARY TITANIUM ABUTMENTS	51
CEMENT- RETAINED ESTHETIC ABUTMENTS	52
CASTING ABUTMENTS	53
IMPLANT ANALOGS	53
PROSTHETIC SCREWS	53
SCREW-RETAINED RESTORATIONS	54
CAD/CAM RESTORATIONS	56
OVERDENTURE RESTORATIONS	58

Conical Narrow Connection (CHC)

Implants

MULTINEO CHC IMPLANT	61
MULTINEO CHC DRILLING SEQUENCE	64
NICE IMPLANT SYSTEM	66
NICE DRILLING SEQUENCE	66

Conical Narrow Connection (CHC)

Prosthetic Line (CHC)

HEALING ABUTMENTS	68
IMPLANT IMPRESSION	69
IMPLANT ANALOGS	69
CEMENT-RETAINED ESTHETIC ABUTMENTS	70
PROSTHETIC SCREWS	72
CASTING ABUTMENTS	72
SCREW-RETAINED RESTORATIONS	74
CAD/CAM RESTORATIONS	76
OVERDENTURE RESTORATIONS	78

Conical Standard Connection (CS)

Implants

MULTINEO CS IMPLANT	81
MULTINEO CS DRILLING SEQUENCE	84

Prosthetic Line (CS)

HEALING ABUTMENTS	86
IMPLANT IMPRESSION	87
IMPLANT ANALOGS	87
CEMENT-RETAINED ESTHETIC ABUTMENTS	88
TEMPORARY TITANIUM ABUTMENTS	88
CASTING ABUTMENTS	88
SCREW-RETAINED RESTORATIONS	89
CAD/CAM RESTORATIONS	91
SCREWS	91
OVERDENTURE RESTORATIONS	93

Guided Surgery

GUIDED SURGERY TOOL KIT (GSTK)	94
GSTK SURGICAL SLEEVES	96
GSTK DRILLS AND TOOLS	97

Appendices

PRODUCT LIST AND REFERENCE NUMBERS	99
ALPHA-BIO TEC'S WARRANTY	112

SIMPLANTOLOGY, IN EVERYTHING WE DO!

At Alpha-Bio Tec., we address the needs of dental professionals, leverage our experience and technologies, utilize experts and invest in research, training and education. All this results in Simplantology: cost-effective solutions that simplify dental implantology procedures and deliver proven clinical success.

DELIVERING TOP-QUALITY, SIMPLE-TO-USE PRODUCTS

We have mastered the art of simplifying implant technology by developing a surgical kit that fits all our products - implants, abutments and surgical tools. Our surgical kit includes basic surgical instrumentation to advanced therapy tools, and is compatible with all product systems. This means that fewer tools are needed to achieve successful results. It simplifies the workflow and minimizes the learning curve. With an overall implant clinical survival rate of 99.6%*, our top-quality implant systems are based on two platforms and three connections with a simple restoration process.

LEVERAGING EXPERIENCE AND TECHNOLOGIES

We leverage our experience and technologies to ensure that our products offer the best value-for-money. For over three decades, we have been focusing on the development and manufacturing of dental implants and their by superstructures & complementary products. Our cutting-edge, in-house manufacturing facility, which is operational 24/7, includes a dedicated QA department to ensure the highest possible standards and quality of our products and the provision of a lifetime warranty for our dental implants.

UTILIZING RESEARCH AND EXPERTS

Our R&D teams collaborate closely with an international panel of experts who have extensive clinical and academic knowledge. We also invest in preclinical in vivo research, clinical trials, histological studies and in vitro laboratory studies. We are also active in all research fields, including basic research, preclinical studies and clinical trials.

TRAINING AND EDUCATING OUR CUSTOMERS

We firmly believe that sharing our know-how and experience is central to ensuring successful and effective implantology work. Every year, we provide more than 150 courses around the world, where we train our customers concerning the latest dental implantology procedures and workflow methods. Course curriculums are based on theoretical background and practical tools covering a range of subjects, including basic implantology, tilted implantation & restoration, guided bone & tissue regeneration, immediate implantation and immediate loading, guided surgery and digital workflows.

EMBRACING THE DIGITALIZATION OF THE DENTAL WORLD

We embrace the technological changes involved in the digitalization of the dental world in order to support the present and future needs of our customers. Consequently, our digital CAD/CAM line offers a wide range of restoration products for our three implant connections. Additionally, our Guided Surgery Tool Kit supports surgery methods and enables dentists to select the software to use when planning surgeries, making their work simpler, more precise and minimally invasive.

*Strietzel F.P., Karmon B., Lorean A., Fischer P. P. Implant-prosthetic rehabilitation of the edentulous maxilla and mandible with immediately loaded Implants preliminary data from a retrospective study, considering time of implantation. JOMI The international Journal of Oral and Maxillofacial Implants 2011, V 26, 1: 139-147

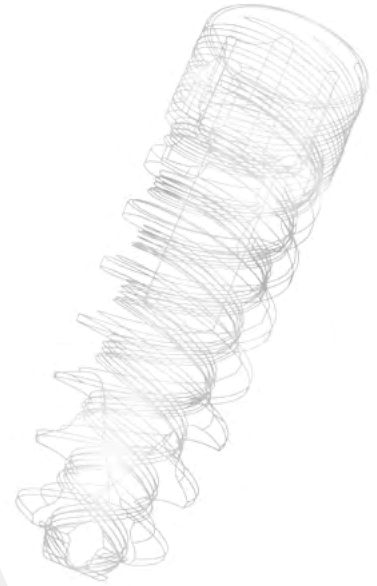

IMPLANT SYSTEMS

From Internal Hex implants to Conical Hex implants, we offer an entire range of implants, so that each physician can find the precise and most convenient implant to work with at any given moment.

PROSTHETICS & CAD/CAM

For each of our implant connections we offer a wide range of options for any clinical need, including fixed and removable restorations, screw based, cemented prosthesis and a wide range of digital CAD/CAM parts. All parts are designed for ease of use and high esthetic appearance.

SURGICAL INSTRUMENTATION

Our universal surgical kit is another demonstration of Alpha-Bio Tec's commitment to simplicity. This one kit provides surgeons all the tools needed to perform most of the procedures, from marking the drilling point to inserting the implant into its final position. Implant orientation tools for the final restoration are also included. Each kit can be customized to meet the dental professional needs. In addition, as digital enablers, Alpha-Bio Tec's Guided Surgery Tool Kit enables accurate and predictable implant procedures using the planning software of the dentist's choice.

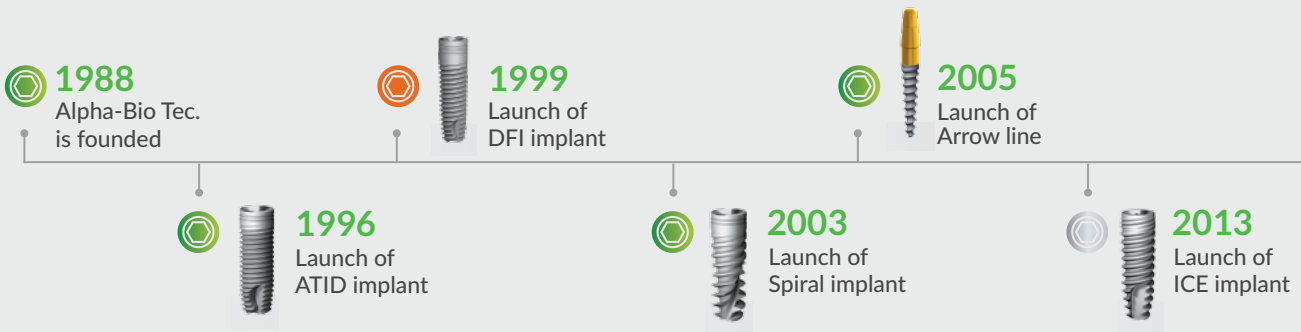

ALPHA-BIO TEC. HAS MASTERED THE ART OF INCORPORATING IMPLANTS AND IMPLANT BASED PROSTHETICS INTO THE DAILY ROUTINE OF DENTAL PROFESSIONALS, BY DEVELOPING PRODUCTS THAT ARE SOPHISTICATED BY DESIGN AND VERY SIMPLE TO USE.

ALPHA-BIO TEC. OFFERS:

- High quality products
- A range of implant systems for surgical procedures in bone types I-IV.
- Solutions for immediate or delayed implant placement & loading in wide or narrow ridges.



  **2014**
Launch of
NICE implant

  **2016**
Launch of
MultiNeO implant

 **2020**
Move to new
modern facilities

 **2015**
Launch of CAD/CAD
Digital Solutions

  **2017**
Launch of Alpha Universe
Multi-Unit One Piece

SMART IMPLANTOLOGY SOLUTIONS

TOP QUALITY PRODUCTS

SIMPLIFIED IMPLANTOLOGY:

Alpha-Bio Tec. implant system is:

- Innovative and easy to use
- Offers simple solutions
- Requires fewer instruments for the procedure

 Internal Hex
Connection (IH)

Ø3.3, Ø3.7N*, Ø3.75, Ø4.2, Ø4.65*, Ø5.0, Ø5.3*, Ø6*

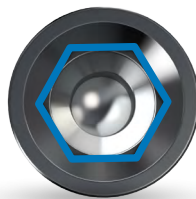

* Diameters available for certain implants only.
Diameters and length information for the various implant systems is available on the respective pages.



Conical Standard Connection (CS)

Ø3.75, Ø4.2, Ø5.0



Conical Narrow Connection (CHC)

Ø3.2, Ø3.5*



* Diameters available for certain implants only.

IMPLANT SURFACE



Worldwide scientific research has proven that the implant surface plays a pivotal role in achieving osseointegration. It has been well documented that surface characteristics of implanted materials highly influence the healing and growth of tissues adjacent to the implant surface.

Alpha-Bio Tec's implants are made of **Titanium alloy Ti 6Al 4V ELI**, a strong, durable and highly biocompatible material. Years of intense research and development lead Alpha-Bio Tec. to develop **NanoTec™** implant surface for optimized osseointegration.

NanoTec implant surface is achieved through a process that involves sandblasting and a double thermal etching for the creation of micropores (sized 1-5 microns). This unique process creates a high surface area differentiation, increases the three-dimensional (3D) surface area and thus, enables a more intense absorption of blood and plasma proteins directly into the implant's micropores immediately after its placement.

The micro-structure and roughness properties of the implant surface created by the sandblasting and double acid etching process, greatly influence the initial contact with the host bone.

The NanoTec process creates a high surface area which contributes to:

- Early osseointegration immediately after placement
- High long-term BIC (Bone to Implant Contact)
- Increased secondary stability
- Higher predictability

SEM of implant surface

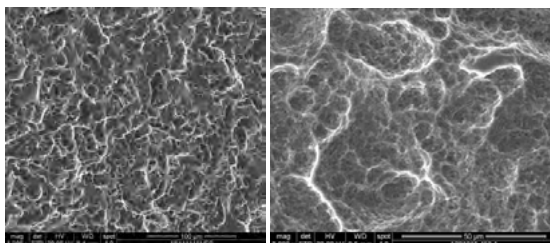

Magnification: X 1000

Magnification: X 3000

Histology of the MultiNeo Implant*

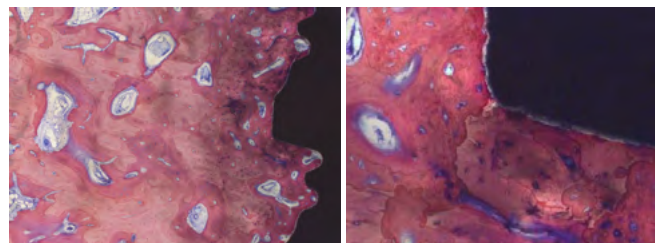

* **References:** Light Microscopy images of the non-decalcified histology staining with Toluidine Blue - Fuchsin. Parietal bone of Sinclair mini pig. The study was performed at GLPIgs, the Pre- Clinical Research Unit at Assaf Harofeh Medical Center, Israel. The surgeries were performed by Prof. Ofer Moses and Dr. Omer Cohen (Tel-Aviv University, Israel). Histology performed by Prof. Dr. Dieter D. Bosshardt from the Robert K. Schenk Laboratory of Oral Histology, University of Bern, Switzerland.

ADVANCED IMPLANT PACKAGE



IMPLANT PACKAGE

A modern and easy-to-use implant package with enhanced ergonomics.



IDENTIFICATION LABELS

Label indicates the implant type, length, diameter and connection (CHC / CS / IH).

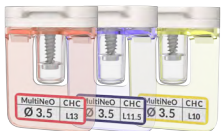

COLOR-CODED HOLDER

Holders are color-coded for easy identification of implant length.



STACKABLE PACKAGING

The unique design enables efficient storage & easy visual identification.



1

Tear the cardboard.



2

Pull the Tyvek®.

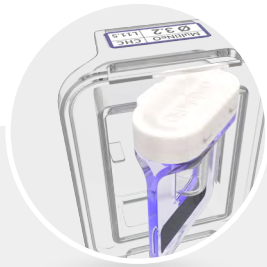

3

Remove the inner holder.

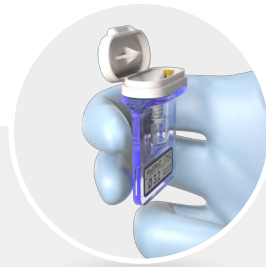

4

Open the cap - easy one-hand operation.

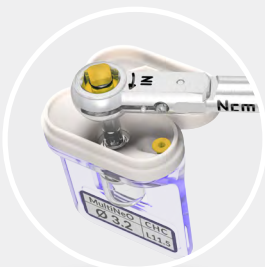

5

Insert the dedicated driver clockwise (Ratchet wrench is for illustration purposes only).



6

Remove the connected implant from the package.



7

Implant can be inserted directly to site.



8

Remove cover screw using an appropriate prosthetic driver.

KITS, DRILLS & TOOLS

Alpha-Bio Tec. is dedicated to making the work of dental professionals as simple as possible. Therefore, we have developed one universal kit with all the tools needed to perform most of the clinical procedures. Each kit can be customized both in size and in tray content to meet clinical needs.

In addition, all drills and tools presented in this chapter are compatible with all implant systems and prosthetic parts (unless indicated otherwise).

ONE KIT FOR ALL IMPLANT SYSTEMS

SURGICAL KIT

Alpha-Bio Tec's surgical kit is suitable for all procedures and implant systems.



- Ergonomic, light and compact, easy to carry
- Clear, color-coded visual design, provides easy and intuitive accessibility
- Laser etched marking on the tray including a dimension bar for effective drill depth verification
- Autoclavable
- Box and tray are made of Radel®
- Stainless steel bath
- Box dimensions : 19 cm X 14 cm X 6 cm

ORDERING INFORMATION: REF. NO. 4699

Kit is provided empty. Tools and drills must be ordered separately.



MINI SURGICAL BOX

A light and compact design for your individual needs.

- Box and tray are made of Radel®
- Autoclavable
- Stainless steel bath
- Box dimensions: 10 cm X 8,5 cm X 5 cm

ORDERING INFORMATION:

REF. NO. 4611	Straight drills mini kit
REF. NO. 4774	Step drills mini kit
REF. NO. 4775	Step drills mini kit without dish

Kit is provided empty. Tools and drills must be ordered separately.

ONE KIT FOR ALL IMPLANT SYSTEMS



One kit for all implants



One-hand opening option



Coated drills

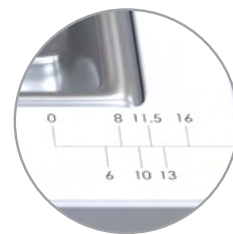

Dimension bar for drill depth

The kits demonstrated are for illustration purposes only. Contents may vary in different markets.

Kit is provided empty. Tools and drills must be ordered separately.

GUIDED SURGERY TOOL KIT (GSTK)

Use the software of your choice with the Alpha-Bio Tec. GSTK

THE KIT IS AVAILABLE IN 3 DIFFERENT CONFIGURATIONS:

	<p>Ref., KIT#65000</p>	<p>Full guided surgery kit for Internal Hex (IH) and Conical Narrow Connections (CHC)</p>
	<p>Ref., KIT#65002</p>	<p>Full guided surgery kit for Conical Standard (CS) and Conical Narrow Connections (CHC)</p>
	<p>Ref., KIT#65003</p>	<p>Full guided surgery kit for Internal Hex (IH), Conical Standard (CS) and Conical Narrow Connections (CHC)</p>

* **Note:** The ratchet is NOT included in the kit.



GUIDED SURGERY TOOL KIT (GSTK)

Use the software of your choice with the Alpha-Bio Tec. GSTK

The tray features a modular layout.

The contents are organized to support the entire guided surgery procedure from site preparation to final implantation.

All kit components fit the matching master sleeves.



- 1

**SITE
PREPARATION**
- 2

OSTEOTOMY
- 3

**IMPLANT
PLACEMENT**
- 4

**TOOLS &
ACCESSORIES**



SURGICAL INSTRUMENTATION

STOPPER KIT

- Compact, ergonomic and esthetic design
- Properly organized, all parts are clearly visible and easily accessed
- Laser markings on both box and stoppers
- Easy cleaning and autoclavable
- Dedicated stoppers extractions grooves
- Materials: Box - Radel®, Cover - PPHT
- Dimension: 13 cm X 9.5 cm X 3 cm

ORDERING INFORMATION: REF. NO. 4612

Kit is provided with 20 stoppers



DRILL STOPPERS

- Compatible with Alpha-Bio Tec. coated DNT² surgical drills
- The stoppers are made from stainless steel, are reusable and autoclavable.

Drill Diameter	GROUP A: Ø 2.0 - Ø 2.4					GROUP B: Ø 2.8 - Ø 3.0				
Drill Depth	L6	L8	L10	L11.5	L13	L6	L8	L10	L11.5	L13
Code	DS-A-L6	DS-A-L8	DS-A-L10	DS-A-L11.5	DS-A-L13	DS-B-L6	DS-B-L8	DS-B-L10	DS-B-L11.5	DS-B-L13
Ref. No.	4561	4562	4563	4564	4565	4566	4567	4568	4569	4570

Drill Diameter	GROUP C: Ø 3.2 - Ø 3.65					GROUP D: Ø 4.1 - Ø 4.5				
Drill Depth	L6	L8	L10	L11.5	L13	L6	L8	L10	L11.5	L13
Code	DS-C-L6	DS-C-L8	DS-C-L10	DS-C-L11.5	DS-C-L13	DS-D-L6	DS-D-L8	DS-D-L10	DS-D-L11.5	DS-D-L13
Ref. No.	4573	4574	4575	4576	4577	4578	4579	4580	4581	4582

SURGICAL DRILLS AND TREPHINES

OTHER DRILLS (STAINLESS STEEL)			
	COUNTERSINK	DRILL EXTENSION	MARKING DRILL
Diameter	2.7-5.9 mm		1.5 mm
Code	CS	DX	MRDX1.5
Ref. No.	4672	4240	4712C
Instructions	For preparation of a bevel within the cortical plate of the alveolar crest	Extends drills by 17.5 mm	For marking of the cortical plate of the alveolar crest

ROUND BURR (STAINLESS STEEL)



Diameter	3 mm
Code	RB3
Ref. No.	4304
Instructions	For various bone manipulations, such as penetration of the cortical plate of the alveolar crest

TREPHINE BURS (STAINLESS STEEL)

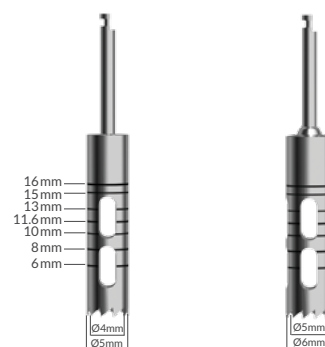

Diameter	4 mm	5 mm
Code	DRT4	DRT5
Ref. No.	4940	4950
Instructions	For bone harvesting and implant removal	

COATED DRILL LINE

- A comprehensive, easy to use drill line
- Long life span and high corrosion resistant
- Color coded
- Compatible with all drill stoppers
- High contrast and clear depth marks
- Multi-layer dark grey coating

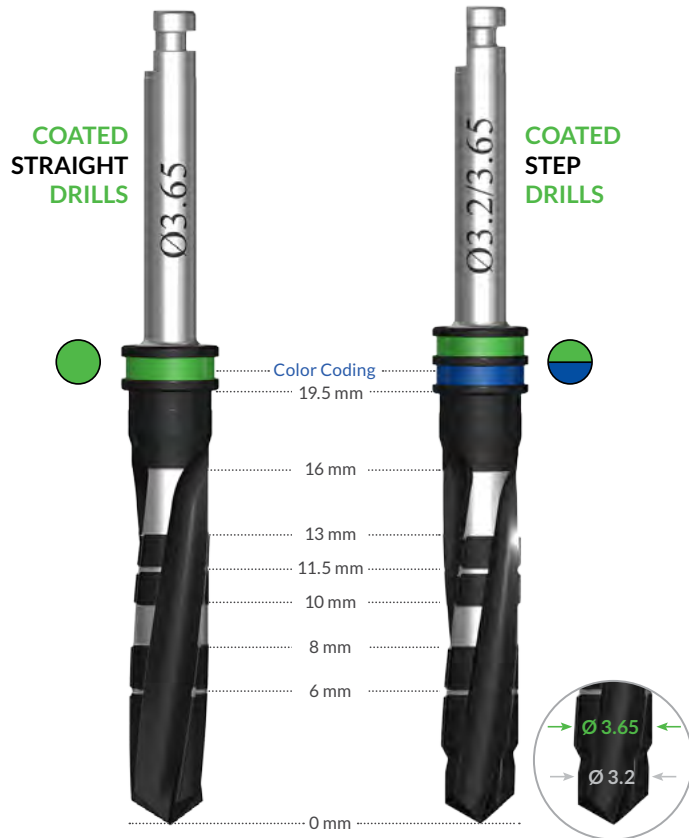

COATED STRAIGHT DRILLS

	Ø 2.0	Ø 2.4	Ø 2.8	Ø 3.0	Ø 3.2	Ø 3.65	Ø 4.1	Ø 4.5	Ø 4.8	Ø 5.2	Ø 5.8
Code	BD2.0	BD2.4	BD2.8	BD3.0	BD3.2	BD3.65	BD4.1	BD4.5	BD4.8	BD5.2	BD5.8
Ref. No.	4550	4551	4552	4553	4554	4555	4556	4557	4558	4559	4560

COATED STEP DRILLS

	Ø 2.0/2.4	Ø 2.4/2.8	Ø 2.8/3.0	Ø 2.8/3.2	Ø 3.2/3.65	Ø 3.65/4.1	Ø 4.1/4.5	Ø 4.5/4.8	Ø 4.8/5.2
Code	BSD2.0-2.4	BSD2.4-2.8	BSD2.8-3.0	BSD2.8-3.2	BSD3.2-3.65	BSD3.65-4.1	BSD4.1-4.5	BSD4.5-4.8	BSD4.8-5.2
Ref. No.	4590	4592	4593	4594	4595	4596	4597	4598	4599

ILLUSTRATION OF THE DRILLING PROTOCOL FOR THE MULTINEO IMPLANT
 Ø3.75 / 13 MM IMPLANT, USING **STEP DRILLS** IN BONE TYPE II / III.

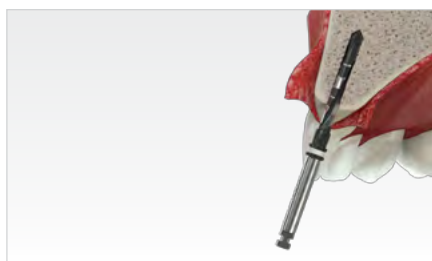

1 Drill with the 2 mm drill

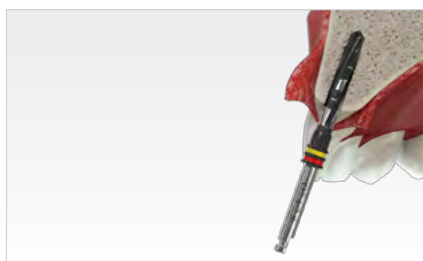

2 Drill with the 2.4 / 2.8 mm step drill



3 Drill with the 2.8 / 3.2 mm step drill



4 Insert the implant into the prepared osteotomy

ILLUSTRATION OF THE DRILLING PROTOCOL FOR THE MULTINEO IMPLANT
 Ø3.75 / 13 MM IMPLANT, USING **STRAIGHT DRILLS** IN BONE TYPE II / III.

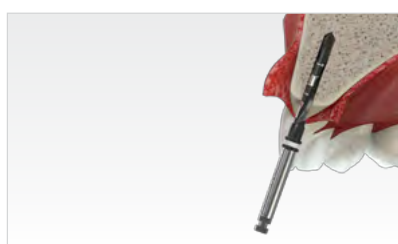

1 Drill with the 2 mm drill

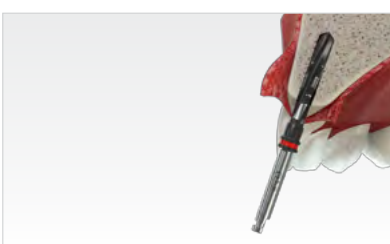

2 Drill with the 2.8 mm straight drill



3 Drill with the 3.2 mm straight drill 3mm shorter than the implant's length



4 Insert the implant into the prepared site

IMPLANT INSERTION TOOLS

IMPLANT INSERTION TOOLS FOR CONICAL NARROW CONNECTION (CHC)



	SHORT 2.1 mm	STANDARD 2.1 mm	LONG 2.1 mm	SHORT MOTOR MOUNT 2.1 mm	LONG MOTOR MOUNT 2.1 mm	MANUAL 2.1 mm
Code	ITD2.1S-CHC	ITD2.1-CHC	ITD2.1L-CHC	IT2.1S M-CHC	IT2.1L M-CHC	MITD2.1 CHC
Ref. No.	7302	7305	7301	7304	7303	4147
Instructions	Fits hexagonal 6.35 mm or square 4 mm ratchet			For use with a contra-angle motor		For manual use

IMPLANT INSERTION TOOLS FOR CONICAL STANDARD CONNECTION (CS)



	SHORT DRIVER 2.5 mm	LONG 2.5 mm	SHORT MOTOR MOUNT 2.5 mm	LONG MOTOR MOUNT 2.5 mm	MANUAL 2.5 mm
Code	ITD2.5 S CS	ITD2.5 L CS	IT2.5 SM CS	IT2.5 LM CS	MITD2.5-CS
Ref. No.	3801	3803	3804	3805	3806
Instructions	Fits hexagonal 6.35 mm or square 4 mm ratchet		For use with a contra-angle motor		For manual use

IMPLANT INSERTION TOOLS

IMPLANT INSERTION TOOLS FOR INTERNAL HEX CONNECTION (IH)



SHORT 2.5 mm	STANDARD 2.5 mm	LONG 2.5 mm	SHORT MOTOR MOUNT 2.5/1.25 mm	LONG MOTOR MOUNT 2.5/1.25 mm	MANUAL 2.5 mm
-----------------	--------------------	----------------	-------------------------------------	------------------------------------	------------------

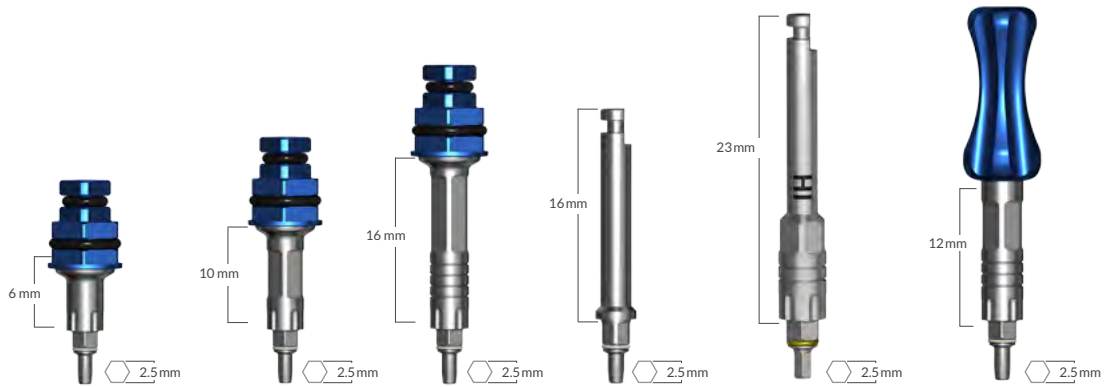

Code	G-ITDS2.5	G-ITDM2.5	G-ITDL2.5	GITS2.5/1.25	GITL2.5/1.25	MITD2.5-IH
Ref. No.	4142	4141	4140	4145	4143	4146
Instructions	Fits hexagonal 6.35 mm or square 4 mm ratchet			For use with a contra-angle motor		For manual use

INTERNAL HEX INSERTION DRIVERS (STAINLESS STEEL)

INTERNAL HEX CONTRA-ANGLE DRIVERS (STAINLESS STEEL)

2.5 mm	Short 2.5 mm
--------	--------------

Motor Mount 2.5/1.25 mm	Short Motor Mount 2.5/1.25 mm
----------------------------	----------------------------------

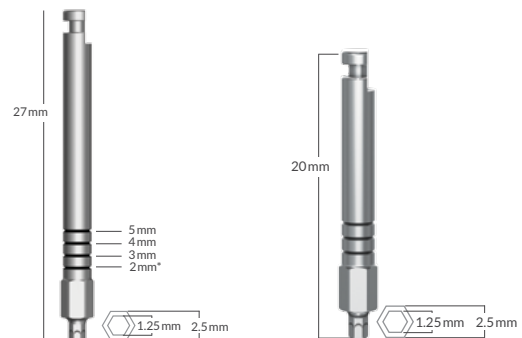
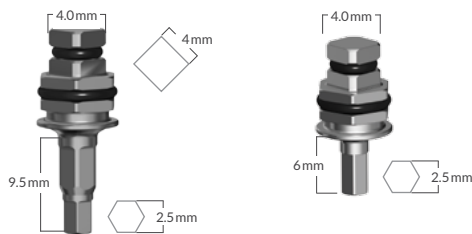

Code	ITD 2.5 S	ITD 2.5 SS
Ref. No.	4152	4153
Instructions	Compatible with hexagonal 6.35 mm or square 4 mm wrench or surgical screw driver	

Code	IT 2.5M+	ITS 2.5/1.25
Ref. No.	4161	4071
Instructions	Used for implant insertion or tightening cover screws, healing abutments and 1.25 mm screws.	

* Compatible with Spiral, DFI and ICE implants provided in packaging with mounted implants.

PARALLEL, DEPTH GUIDES & SURGICAL ACCESSORIES

SURGICAL SCREWDRIVER
(Stainless Steel)

Ref. No. 4220
Code: SDH



Used with 6.35 mm hexagonal head.

UNIVERSAL TORQUE RATCHET
10-45 Ncm (Stainless Steel)

Ref. No. 4572
Code: URT



Allows clinicians to accurately apply the recommended torque when using prosthetic or surgical drivers.
Can be adapted for use with the 4 mm square heads drivers when using USH 4012.

PARALLEL/DEPTH GUIDE (TITANIUM)

PARALLEL GUIDE (TITANIUM)

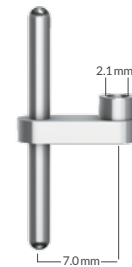
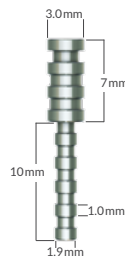
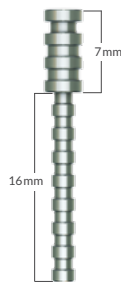

Code	PDG	PDGS	PG
Ref. No.	4080	4081	4082
Instructions	For accurate measurement of osteotomy depth, parallel check and X-ray distortion. Each step is 1 mm.		Used for precise spacing and parallel implant placement.

* Compatible with Internal Hex & Conical Hex Connection platforms.



IDG IMPLANT DEPTH PROBE (STAINLESS STEEL)



Code	IDG
Ref. No.	4100
Instructions	Double sided measuring probe: 1.9 mm width of the rounded apex is used for examinations of osteotomy made by the 2 mm drill. 2.7 mm width of the rounded apex is used for examinations of osteotomy made by the 2.8 mm drill. Can be used in various treatments: checking osteotomy depth, examination of the Schneiderian membrane, bone condensing and others.

PROSTHETICS INSERTION TOOLS

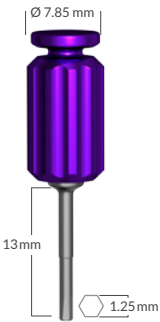
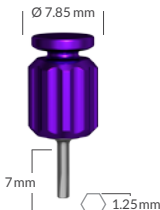
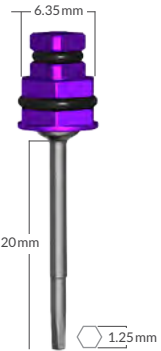
HEX DRIVERS

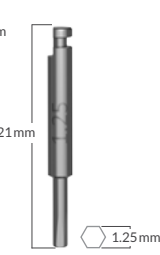
HEX DRIVERS 1.25 MM (STAINLESS STEEL)						
Manual Grip Driver	Short Manual Grip Driver	Long Hex Driver	Hex Driver	Short Hex Driver	Motor Mount	
						
Code	HHS 1.25	HHSS 1.25	HTD 1.25L	HTD 1.25	HTD 1.25 S	HT 1.25M
Ref. No.	4052	4053	4061	4055	4056	4165
Instructions	For manual use		Fits hexagonal 6.35 mm or square 4 mm ratchet			For use with a contra-angle motor
Compatible with all healing abutments, cover screws, transfer screws and most abutments.						

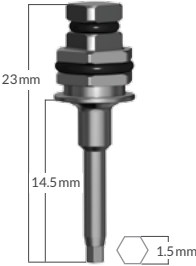
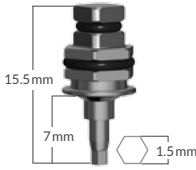
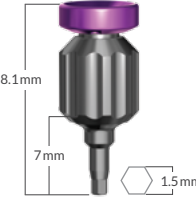
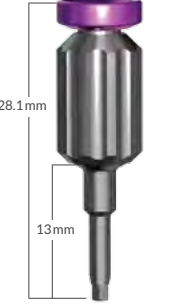
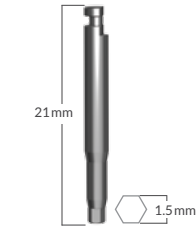



HEX DRIVERS 1.5 MM (STAINLESS STEEL)					
Hex Driver 1.5mm	Short Hex Driver 1.5mm	Manual Driver 1.5mm	Long Manual Driver 1.5mm	Motor Mount 1.5 mm	
					
Code	HTD 1.5	HTD 1.5S	HHS 1.5	HHL 1.5	HT 1.5
Ref. No.	4057	4058	4059	4060	4168
Instructions	Fits hexagonal 6.35 mm or square 4 mm ratchet		For manual use		For use with a contra-angle motor
For use with Multi-Unit straight abutments only (TCT). See pages 54, 55, 74, 75, 89, 90					



Internal Hex Connection (IH)

Alpha-Bio Tec's Internal Hex platform enables a simple restoration procedure.



CONNECTION	 INTERNAL HEX	 INTERNAL HEX
	Active implant designed for immediate implant procedures in a variety of bone types	The original spiral implant
RECOMMENDED BONE TYPE		
DESIGN FEATURES	<ul style="list-style-type: none"> • Tapered • Centering and anchoring features • Double, variable threads • Micro-threads 	<ul style="list-style-type: none"> • Osteotome-like condensing body • Pronounced tapered core • Apical part with sharp deep threads
CLINICAL BENEFITS	<ul style="list-style-type: none"> • High primary stability • Reduced marginal bone loss • Increased surface area • Increased BIC 	<ul style="list-style-type: none"> • High primary stability • Easy & smooth insertion • Redirection capabilities • Reduced marginal bone loss • Increased BIC

ULTIMATE

DYNAMIC







* Formerly SPI



Ø3.3, Ø3.7N*, Ø3.75, Ø4.2, Ø4.65*, Ø5.0, Ø5.3*, Ø6*



 INTERNAL HEX	 INTERNAL HEX
For cases of classic implant placement, immediate placement & loading	Cylindrical, slightly tapered implant for a wide range of dental procedures
	
<ul style="list-style-type: none"> • Moderately tapered • Back tapered coronal part** • Split coronal micro-threads 	<ul style="list-style-type: none"> • Slightly tapered • Double thread design with variable threads
<ul style="list-style-type: none"> • Improved stress distribution • Supports wide range of clinical cases • Controlled bone penetration 	<ul style="list-style-type: none"> • Easily stabilized & controlled during placement • Long-term stability • Large surface area
UNIVERSAL	CLASSIC

** ICE implants with Ø4.2, Ø4.65 and Ø5.3 in lengths 10 mm and longer.

MULTINEO™ MULTIPLE OPTIONS

RECOMMENDED BONE TYPE





DESIGN FEATURES

- Tapered
- Centering and anchoring features
- Double, variable threads
- Micro-threads

CLINICAL BENEFITS

- High primary stability
- Reduced marginal bone loss
- Increased surface area
- Increased BIC



Ø Diameter	Length	Ref. No.	Dimensions				
			A	B	C	D	H
 Ø 3.75	8 mm	1968	Ø 3.75	Ø 3.1	Ø 1.8	Ø 3.5	Ø 2.5
	10 mm	1960	Ø 3.75	Ø 2.9	Ø 1.5	Ø 3.5	Ø 2.5
	11.5 mm	1961	Ø 3.75	Ø 2.9	Ø 1.5	Ø 3.5	Ø 2.5
	13 mm	1963	Ø 3.75	Ø 2.9	Ø 1.5	Ø 3.5	Ø 2.5
	16 mm	1966	Ø 3.75	Ø 2.9	Ø 1.5	Ø 3.5	Ø 2.5
 Ø 4.2	8 mm	1978	Ø 4.2	Ø 3.55	Ø 1.8	Ø 3.5	Ø 2.5
	10 mm	1970	Ø 4.2	Ø 3.3	Ø 1.8	Ø 3.5	Ø 2.5
	11.5 mm	1971	Ø 4.2	Ø 3.3	Ø 1.8	Ø 3.5	Ø 2.5
	13 mm	1973	Ø 4.2	Ø 3.3	Ø 1.8	Ø 3.5	Ø 2.5
	16 mm	1976	Ø 4.2	Ø 3.3	Ø 1.8	Ø 3.5	Ø 2.5
 Ø 5.0	8 mm	1988	Ø 5.0	Ø 4.4	Ø 2.6	Ø 3.5	Ø 2.5
	10 mm	1980	Ø 5.0	Ø 4.1	Ø 2.3	Ø 3.5	Ø 2.5
	11.5 mm	1981	Ø 5.0	Ø 4.1	Ø 2.3	Ø 3.5	Ø 2.5
	13 mm	1983	Ø 5.0	Ø 4.1	Ø 2.3	Ø 3.5	Ø 2.5

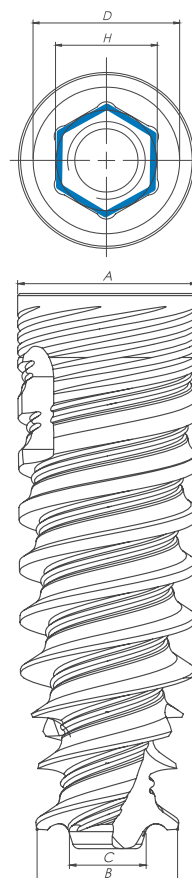

IMPLANT SYSTEM

IMPLANT PACKAGE

A modern and easy-to-use implant package with enhanced ergonomics.



DRIVERS

Color coded grip drivers with gingival height markings and lead pin for centering and easy insertion.



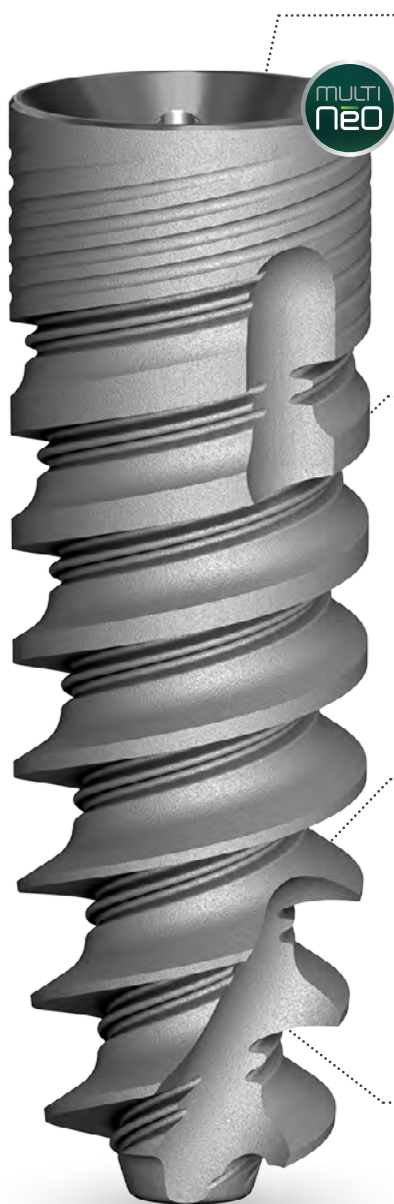

CORONAL PART

Design Features:

- Platform Switching
- Micro-threads
- Cutting flutes
- Internal hex and Conical standard

Clinical Benefits:

- Reduced pressure on cortical area
- Efficient cutting ability
- Improved bone preservation
- High initial stability

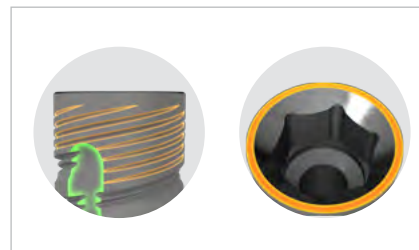

IMPLANT THREADS

Design Features:

- Variable thread design
- Double thread with 2.4mm step
- Micro-threads

Clinical Benefits:

- High cutting efficiency
- Osteotome like body
- Fast and controlled insertion
- Increased surface area
- Increased BIC

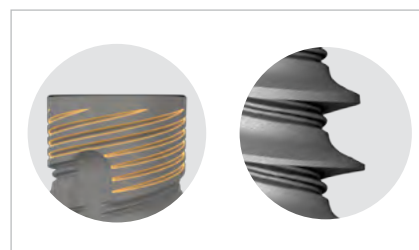

IMPLANT BODY AND CORE

Design Features:

- Straight coronal part
- Slightly tapered body
- Tapered core
- Tapered apical part

Clinical Benefits:

- Osteotome like body
- High primary stability

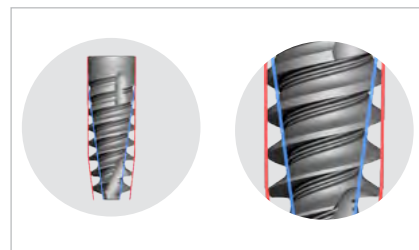

APICAL PART

Design Features:

- Narrow apex
- Sharp and deep threads
- Patented centering feature

Clinical Benefits:

- High primary stability
- Easy navigation and penetration
- Efficient cutting capability

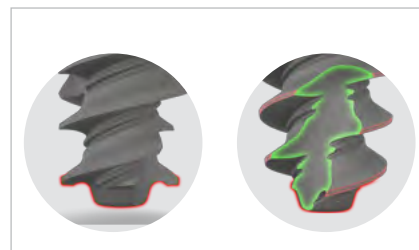

MULTINEO™ MULTIPLE OPTIONS

STEP DRILLING SEQUENCE

Ø 3.75

Bone Type IV			Bone Type II & III			Bone Type I				
Ø2.0	Ø2.4/Ø2.8		Ø2.0	Ø2.4/Ø2.8	Ø2.8/Ø3.2	Ø2.0	Ø2.4/Ø2.8	Ø2.8/Ø3.2	Ø3.2/Ø3.65	Cortical*



Ø 4.2

Bone Type IV			Bone Type II & III			Bone Type I				
Ø2.0	Ø2.4/Ø2.8	Ø2.8/Ø3.2	Ø2.0	Ø2.4/Ø2.8	Ø3.2/Ø3.65	Ø2.0	Ø2.4/Ø2.8	Ø3.2/Ø3.65	Ø3.65/Ø4.1	Cortical*



Ø 5.0

Bone Type IV			Bone Type II & III				Bone Type I						
Ø2.0	Ø2.4 / Ø2.8	Ø3.2 / Ø3.65	Ø2.0	Ø2.4 / Ø2.8	Ø3.2 / Ø3.65	Ø3.65 / Ø4.1	Ø2.0	Ø2.4 / Ø2.8	Ø3.2 / Ø3.65	Ø3.65 / Ø4.1	Ø4.1 / Ø4.5	Ø4.5 / Ø4.8	Cortical*



* Cortical - Drill through cortical plate with the larger diameter.

STRAIGHT DRILLING SEQUENCE

Ø 3.75

Bone Type IV			Bone Type II & III			Bone Type I				
Ø2.0	Ø2.4	Ø2.8**	Ø2.0	Ø2.8	Ø3.2**	Ø2.0	Ø2.8	Ø3.2**	Ø3.65	Cortical*



Ø 4.2

Bone Type IV			Bone Type II & III				Bone Type I					
Ø2.0	Ø2.8	Ø3.2**	Ø2.0	Ø2.8	Ø3.2	Ø3.65**	Ø2.0	Ø2.8	Ø3.2	Ø3.65**	Ø4.1	Cortical*



Ø 5.0

Bone Type IV				Bone Type II & III					Bone Type I							
Ø2.0	Ø2.8	Ø3.2	Ø3.65**	Ø2.0	Ø2.8	Ø3.2	Ø3.65	Ø4.1**	Ø2.0	Ø2.8	Ø3.2	Ø3.65	Ø4.1	Ø4.5**	Ø4.8	Cortical*



* Cortical - Drill through cortical plate.

** 3mm shorter than implant's length. Note that drill can be replaced by a corresponding step drill throughout entire implant's length. For more information, see step protocol.

Important: Professional considerations may be required for adaptations of the drill protocol in specific cases.



RECOMMENDED BONE TYPE	
DESIGN FEATURES	<ul style="list-style-type: none"> • Moderately tapered • Back tapered coronal part* • Split coronal micro-threads
CLINICAL BENEFITS	<ul style="list-style-type: none"> • Improved stress distribution • Supports wide range of clinical cases • Controlled bone penetration



Ø Diameter	Length	Ref. No.	Dimensions				
			A	B	C	D	P
 Ø 3.7N	10 mm	1000	Ø 3.7	Ø 2.2	Ø 1	Ø 3.5	Ø 3.7
	11.5 mm	1001	Ø 3.7	Ø 2.2	Ø 1	Ø 3.5	Ø 3.7
	13 mm	1003	Ø 3.7	Ø 2.2	Ø 1	Ø 3.5	Ø 3.7
 Ø 3.75	8 mm	1018	Ø 3.75	Ø 2.6	Ø 1.6	Ø 3.5	Ø 3.75
	10 mm	1010	Ø 3.75	Ø 2.6	Ø 1.6	Ø 3.5	Ø 3.75
	11.5 mm	1011	Ø 3.75	Ø 2.6	Ø 1.6	Ø 3.5	Ø 3.75
	13 mm	1013	Ø 3.75	Ø 2.6	Ø 1.6	Ø 3.5	Ø 3.75
 Ø 4.2	6 mm	1056	Ø 4.2	Ø 2.7	Ø 2.7	Ø 3.5	Ø 4.2
	8 mm	1028	Ø 4.2	Ø 2.8	Ø 1.8	Ø 3.5	Ø 4.2
	10 mm	1020	Ø 4.2	Ø 2.8	Ø 1.8	Ø 3.5	Ø 4
	11.5 mm	1021	Ø 4.2	Ø 2.8	Ø 1.8	Ø 3.5	Ø 4
	13 mm	1023	Ø 4.2	Ø 2.8	Ø 1.8	Ø 3.5	Ø 4
	16 mm	1026	Ø 4.2	Ø 2.8	Ø 1.8	Ø 3.5	Ø 4
 Ø 4.65	6 mm	1036	Ø 4.65	Ø 2.9	Ø 2.9	Ø 3.85	Ø 4.65
	8 mm	1038	Ø 4.65	Ø 3	Ø 2	Ø 3.85	Ø 4.65
	10 mm	1030	Ø 4.65	Ø 3	Ø 2	Ø 3.85	Ø 4.45
	11.5 mm	1031	Ø 4.65	Ø 3	Ø 2	Ø 3.85	Ø 4.45
	13 mm	1033	Ø 4.65	Ø 3	Ø 2	Ø 3.85	Ø 4.45
 Ø 5.3	6 mm	1046	Ø 5.3	Ø 3.8	Ø 3.8	Ø 3.85	Ø 5.3
	8 mm	1048	Ø 5.3	Ø 3.45	Ø 2.45	Ø 3.85	Ø 5.3
	10 mm	1040	Ø 5.3	Ø 3.45	Ø 2.45	Ø 3.85	Ø 5.1
	11.5 mm	1041	Ø 5.3	Ø 3.45	Ø 2.45	Ø 3.85	Ø 5.1
	13 mm	1043	Ø 5.3	Ø 3.45	Ø 2.45	Ø 3.85	Ø 5.1

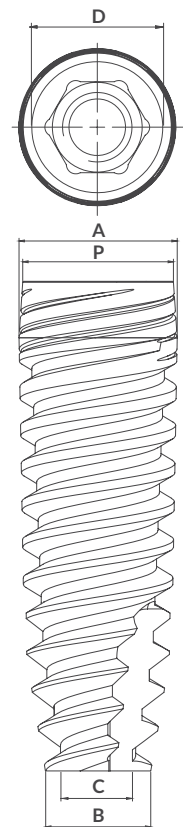

Important: Professional considerations may be required for adaptations of the drill protocol in specific cases.

* ICE implants with 4.2, 4.65 and 5.3 in lengths 10 mm and longer.

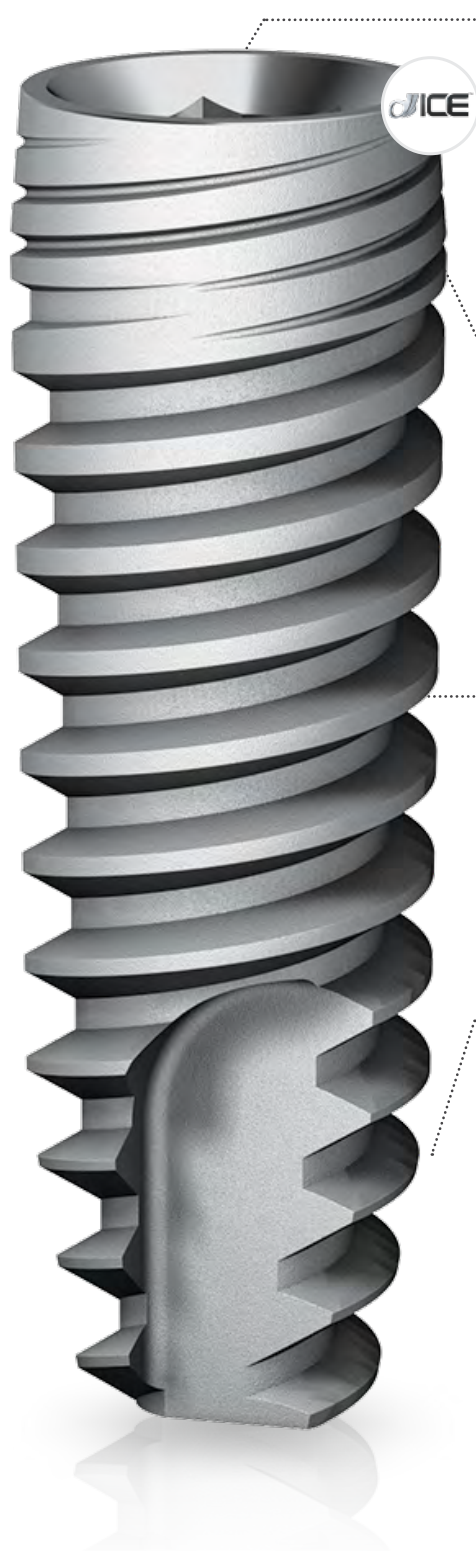

IMPLANT-ABUTMENT CONNECTION

Design Features:

- Internal Hex connection
- One platform for all diameters
- Platform switching

Clinical Benefits:

- Tight implant-abutment fit*
- Simple restoration process

CORONAL PART

Design Features:

- Micro-threads
- Back tapered**
- Rough surface

Clinical Benefits:

- Reduced Marginal Bone Loss
- Decreased crestal stress
- Increased BIC (Bone Implant Contact)

IMPLANT BODY AND CORE

Design Features:

- Moderately tapered body
- Slightly tapered apical area
- Osteotome- like shape

Clinical Benefits:

- Smooth & controlled insertion
- Good primary stability

APICAL PART

Design Features:

- Sharp and deep threads
- Cutting flute

Clinical Benefits:

- Smooth and controlled insertion
- Good primary stability

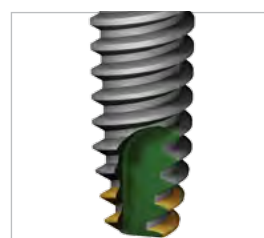
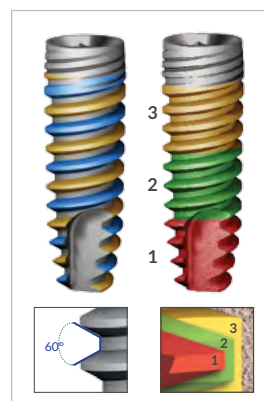
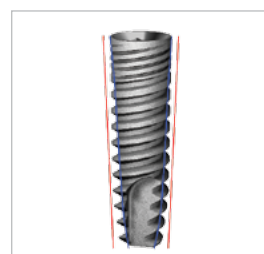









* Do not use I.C.E. implants with wide analog Ref. No. 5280 (IA5)

** ICE implants with Ø4.2, Ø4.65 and Ø5.3 in lengths 10 mm and longer.









STEP DRILLING SEQUENCE

Ø 3.7N

Bone Type IV		Bone Type II & III			Bone Type I			
Ø2.0	Ø2.0/Ø2.4	Ø2.0	Ø2.4/Ø2.8	Ø2.8/Ø3.2	Ø2.0	Ø2.4/Ø2.8	Ø2.8/Ø3.2	Ø3.2/Ø3.65 Cortical*
								













Ø 3.75

Bone Type IV		Bone Type II & III			Bone Type I			
Ø2.0	Ø2.4/Ø2.8	Ø2.0	Ø2.4/Ø2.8	Ø2.8/Ø3.2	Ø2.0	Ø2.4/Ø2.8	Ø2.8/Ø3.2	Ø3.2/Ø3.65 Cortical*
								















Ø 4.2

Bone Type IV			Bone Type II & III			Bone Type I			
Ø2.0	Ø2.4/Ø2.8	Ø2.8/Ø3.2	Ø2.0	Ø2.4/Ø2.8	Ø3.2/Ø3.65	Ø2.0	Ø2.4/Ø2.8	Ø3.2/Ø3.65	Ø3.65/Ø4.1 Cortical*
									

















Ø 4.65

Bone Type IV			Bone Type II & III				Bone Type I				
Ø2.0	Ø2.4 / Ø2.8	Ø3.2 / Ø3.65	Ø2.0	Ø2.4 / Ø2.8	Ø3.2 / Ø3.65	Ø3.65 / Ø4.1	Ø2.0	Ø2.4 / Ø2.8	Ø3.2 / Ø3.65	Ø3.65 / Ø4.1	Ø4.1 / Ø4.5 Cortical*
											



Ø 5.3

Bone Type IV				Bone Type II & III					Bone Type I					
Ø2.0	Ø2.4 / Ø2.8	Ø3.2 / Ø3.65	Ø3.65 / Ø4.1	Ø2.0	Ø2.4 / Ø2.8	Ø3.2 / Ø3.65	Ø3.65 / Ø4.1	Ø4.5 / Ø4.8	Ø2.0	Ø2.4 / Ø2.8	Ø3.2 / Ø3.65	Ø3.65 / Ø4.1	Ø4.5 / Ø4.8	Ø4.8 / Ø5.2 Cortical*
														



* Cortical - Drill through cortical plate with the larger diameter.

Important: Professional considerations may be required for adaptations of the drill protocol in specific cases.

STRAIGHT DRILLING SEQUENCE

Ø 3.7N

Bone Type IV		Bone Type II & III			Bone Type I			
Ø2.0	Ø2.4**	Ø2.0	Ø2.8	Ø3.2**	Ø2.0	Ø2.8	Ø3.2**	Ø3.65 Cortical*



Ø 3.75

Bone Type IV			Bone Type II & III			Bone Type I			
Ø2.0	Ø2.4	Ø2.8**	Ø2.0	Ø2.8	Ø3.2**	Ø2.0	Ø2.8	Ø3.2**	Ø3.65 Cortical*



Ø 4.2

Bone Type IV			Bone Type II & III				Bone Type I				
Ø2.0	Ø2.8	Ø3.2**	Ø2.0	Ø2.8	Ø3.2	Ø3.65**	Ø2.0	Ø2.8	Ø3.2	Ø3.65**	Ø4.1 Cortical*



Ø 4.65

Bone Type IV				Bone Type II & III				
Ø2.0	Ø2.8	Ø3.2	Ø3.65**	Ø2.0	Ø2.8	Ø3.2	Ø3.65	Ø4.1**

Hard Bone Type I							
Ø2.0	Ø2.8	Ø3.2	Ø3.65	Ø4.1**	Ø4.5 Cortical*		



Ø 5.3

Bone Type IV					Bone Type II & III						
Ø2.0	Ø2.8	Ø3.2	Ø3.65	Ø4.1**	Ø2.0	Ø2.8	Ø3.2	Ø3.65	Ø4.1	Ø4.5	Ø4.8**

Hard Bone Type I							
Ø2.0	Ø2.8	Ø3.2	Ø3.65	Ø4.1	Ø4.5	Ø4.8**	Ø5.2 Cortical*



* Cortical – Drill through cortical plate

** 3mm shorter than implant's length. Note that drill can be replaced by a corresponding step drill throughout entire implant's length. For more information, see step protocol.

Spiral THE ORIGINAL SPIRAL IMPLANT



RECOMMENDED BONE TYPE	
DESIGN FEATURES	<ul style="list-style-type: none"> • Osteotome-like condensing body • Pronounced tapered core • Apical part with sharp deep threads
CLINICAL BENEFITS	<ul style="list-style-type: none"> • High primary stability • Easy & smooth insertion • Redirection capabilities • Reduced marginal bone loss • Increased BIC



Ø Diameter	Length	Ref. No.	Dimensions			
			A	B	C	D
 Ø 3.3	8 mm	1308	Ø 3.7	Ø 2.55	Ø 1.55	Ø 3.5
	10 mm	1300	Ø 3.7	Ø 2.55	Ø 1.55	Ø 3.5
	11.5 mm	1301	Ø 3.7	Ø 2.55	Ø 1.55	Ø 3.5
	13 mm	1303	Ø 3.7	Ø 2.55	Ø 1.55	Ø 3.5
	16 mm	1306	Ø 3.7	Ø 2.55	Ø 1.55	Ø 3.5
 Ø 3.75	8 mm	1358	Ø 3.85	Ø 2.9	Ø 2	Ø 3.5
	10 mm	1350	Ø 3.85	Ø 2.9	Ø 2	Ø 3.5
	11.5 mm	1351	Ø 3.85	Ø 2.9	Ø 2	Ø 3.5
	13 mm	1353	Ø 3.85	Ø 2.9	Ø 2	Ø 3.5
	16 mm	1356	Ø 3.85	Ø 2.9	Ø 2	Ø 3.5
 Ø 4.2	8 mm	1338	Ø 4.2	Ø 3	Ø 2.1	Ø 3.85
	10 mm	1330	Ø 4.2	Ø 3	Ø 2.1	Ø 3.85
	11.5 mm	1331	Ø 4.2	Ø 3	Ø 2.1	Ø 3.85
	13 mm	1333	Ø 4.2	Ø 3	Ø 2.1	Ø 3.85
	16 mm	1336	Ø 4.2	Ø 3	Ø 2.1	Ø 3.85
 Ø 5	8 mm	1348	Ø 4.95	Ø 3.3	Ø 2.6	Ø 3.85
	10 mm	1340	Ø 4.95	Ø 3.3	Ø 2.6	Ø 3.85
	11.5 mm	1341	Ø 4.95	Ø 3.3	Ø 2.6	Ø 3.85
	13 mm	1343	Ø 4.95	Ø 3.3	Ø 2.6	Ø 3.85
	16 mm	1346	Ø 4.95	Ø 3.3	Ø 2.6	Ø 3.85
 Ø 6	8 mm	1368	Ø 5.95	Ø 4.6	Ø 3.35	Ø 3.85
	10 mm	1360	Ø 5.95	Ø 4.6	Ø 3.45	Ø 3.85
	11.5 mm	1361	Ø 5.95	Ø 4.6	Ø 3.45	Ø 3.85
	13 mm	1363	Ø 5.95	Ø 4.6	Ø 3.45	Ø 3.85

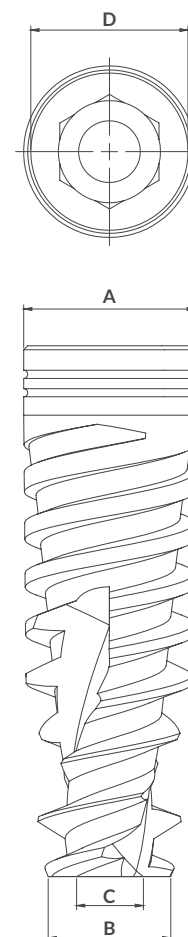

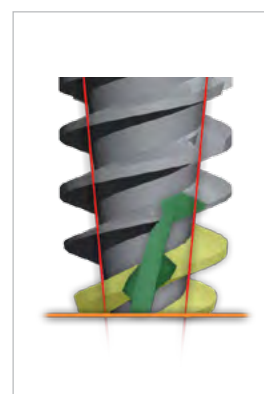
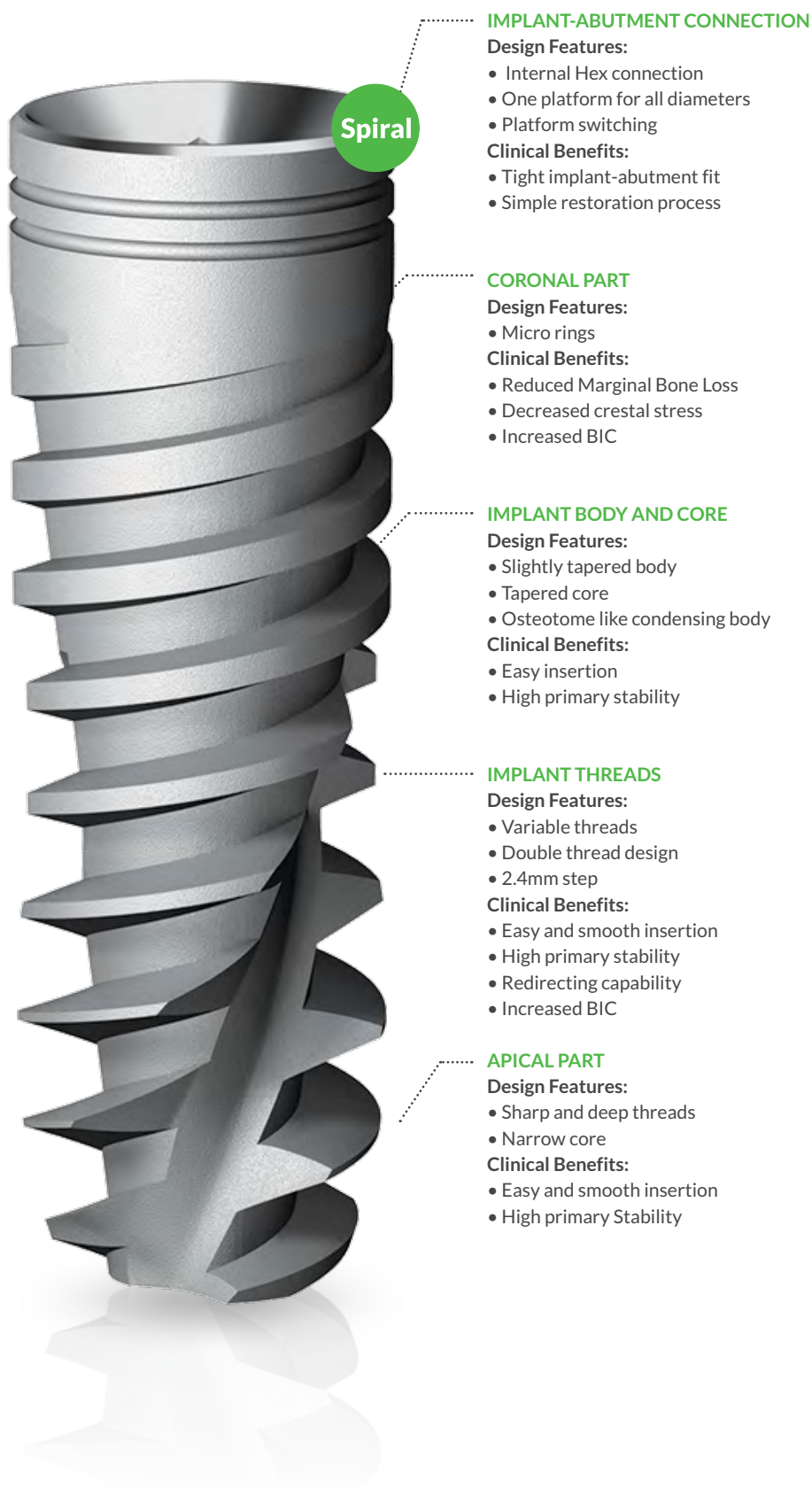

Note: The illustration shows Spiral implant $\varnothing 3.75 / 13$ mm

STRAIGHT DRILLING SEQUENCE

Ø 3.3

Bone Type IV		Bone Type II & III		Bone Type I		
Ø2.0		Ø2.0	Ø2.8	Ø2.0	Ø2.8	Ø3.2 Cortical*

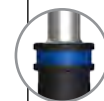

Ø 3.75

Bone Type IV		Bone Type II & III			Bone Type I			
Ø2.0	Ø2.8	Ø2.0	Ø2.8	Ø3.2	Ø2.0	Ø2.8	Ø3.2	Ø3.65 Cortical*



Ø 4.2

Bone Type IV			Bone Type II & III				Bone Type I				
Ø2.0	Ø2.8	Ø3.2	Ø2.0	Ø2.8	Ø3.2	Ø3.65	Ø2.0	Ø2.8	Ø3.2	Ø3.65	Ø4.1 Cortical*

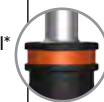

Ø 5.0

Bone Type IV				Bone Type II & III					
Ø2.0	Ø2.8	Ø3.2	Ø3.65	Ø2.0	Ø2.8	Ø3.2	Ø3.65	Ø4.1	Ø4.5

Hard Bone Type I						
Ø2.0	Ø2.8	Ø3.2	Ø3.65	Ø4.1	Ø4.5	Ø4.8 Cortical*



Ø 6.0

Bone Type IV						Bone Type II & III						
Ø2.0	Ø2.8	Ø3.2	Ø3.65	Ø4.1	Ø4.8	Ø2.0	Ø2.8	Ø3.2	Ø3.65	Ø4.1	Ø4.8	Ø5.2

Hard Bone Type I							
Ø2.0	Ø2.8	Ø3.2	Ø3.65	Ø4.1	Ø4.8	Ø5.2	Ø5.8 Cortical*



* Cortical - Drill through cortical plate with the larger diameter.



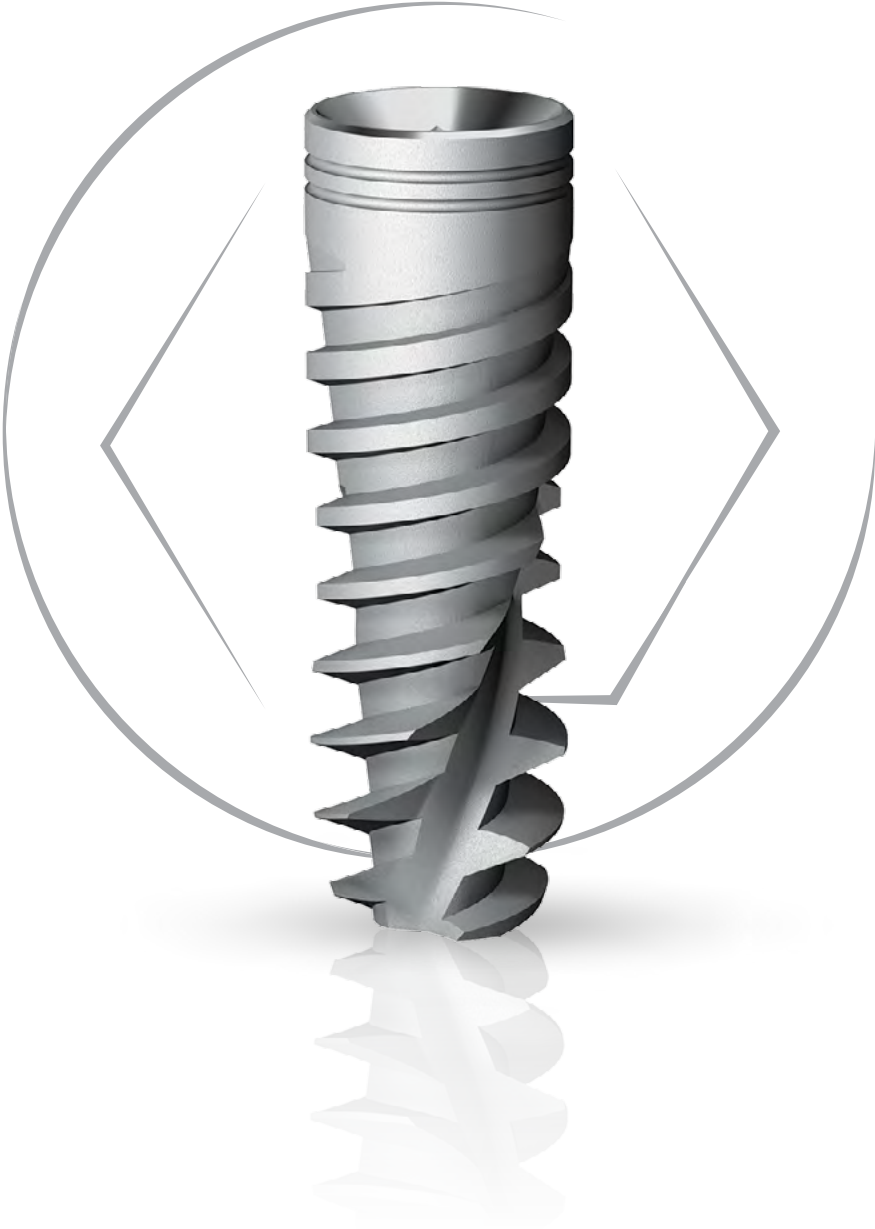

Important: Professional considerations may be required for adaptations of the drill protocol in specific cases.

Spiral THE ORIGINAL SPIRAL IMPLANT



RECOMMENDED BONE TYPE	● I ● II ● III ● IV
DESIGN FEATURES	<ul style="list-style-type: none"> Slightly tapered Double thread design with variable threads
CLINICAL BENEFITS	<ul style="list-style-type: none"> Easily controlled during placement Long-term stability Large surface area

HIGHLY RECOMMENDED  OPTIONAL

Ø Diameter	Length	Ref. No.	Dimensions			
			A	B	C	D
Ø 3.3 	8 mm	1288	Ø 3.7	Ø 2.6	Ø 2.1	Ø 3.5
	10 mm	1280	Ø 3.7	Ø 2.6	Ø 2.1	Ø 3.5
	11.5 mm	1281	Ø 3.7	Ø 2.6	Ø 2.1	Ø 3.5
	13 mm	1283	Ø 3.7	Ø 2.6	Ø 2.1	Ø 3.5
Ø 3.75 	8 mm	1268	Ø 3.85	Ø 3	Ø 2.1	Ø 3.5
	10 mm	1260	Ø 3.85	Ø 3	Ø 2.1	Ø 3.5
	11.5 mm	1261	Ø 3.85	Ø 3	Ø 2.1	Ø 3.5
	13 mm	1263	Ø 3.85	Ø 3	Ø 2.1	Ø 3.5
Ø 4.2 	8 mm	1278	Ø 4.2	Ø 3	Ø 2.2	Ø 3.85
	10 mm	1270	Ø 4.2	Ø 3	Ø 2.2	Ø 3.85
	11.5 mm	1271	Ø 4.2	Ø 3	Ø 2.2	Ø 3.85
	13 mm	1273	Ø 4.2	Ø 3	Ø 2.2	Ø 3.85
Ø 5 	8 mm	1298	Ø 4.95	Ø 4.05	Ø 3.1	Ø 3.85
	10 mm	1290	Ø 4.95	Ø 4.05	Ø 3.1	Ø 3.85
	11.5 mm	1291	Ø 4.95	Ø 4.05	Ø 3.1	Ø 3.85
	13 mm	1293	Ø 4.95	Ø 4.05	Ø 3.1	Ø 3.85

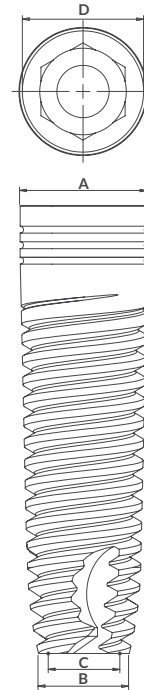

STRAIGHT DRILLING SEQUENCE

Ø 3.3	Bone Type IV				Bone Type II & III				Bone Type I				
	Ø 2.0	Ø 2.8	Cortical*		Ø 2.0	Ø 2.8	Ø 2.0	Ø 2.8	Ø 3.2	Cortical*			
Ø 3.75	Bone Type IV				Bone Type II & III				Bone Type I				
	Ø 2.0	Ø 2.8	Ø 3.2	Cortical*	Ø 2.0	Ø 2.8	Ø 3.2	Ø 2.0	Ø 2.8	Ø 3.2	Ø 3.65	Cortical*	
Ø 4.2	Bone Type IV				Bone Type II & III				Bone Type I				
	Ø 2.0	Ø 2.8	Ø 3.2	Ø 3.65 Cortical*	Ø 2.0	Ø 2.8	Ø 3.2	Ø 3.65	Ø 2.0	Ø 2.8	Ø 3.2	Ø 3.65	
Ø 5.0	Bone Type IV				Bone Type II & III				Bone Type I				
	Ø 2.0	Ø 2.8	Ø 3.2	Ø 3.65	Ø 4.1	Ø 4.5 Cortical*	Ø 2.0	Ø 2.8	Ø 3.2	Ø 3.65	Ø 4.1	Ø 4.5	
	Hard Bone Type I												
Ø 2.0	Ø 2.8	Ø 3.2	Ø 3.65	Ø 4.1	Ø 4.5	Ø 2.0	Ø 2.8	Ø 3.2	Ø 3.65	Ø 4.1	Ø 4.5	Ø 4.8 Cortical*	

*Cortical – Drill through cortical plate

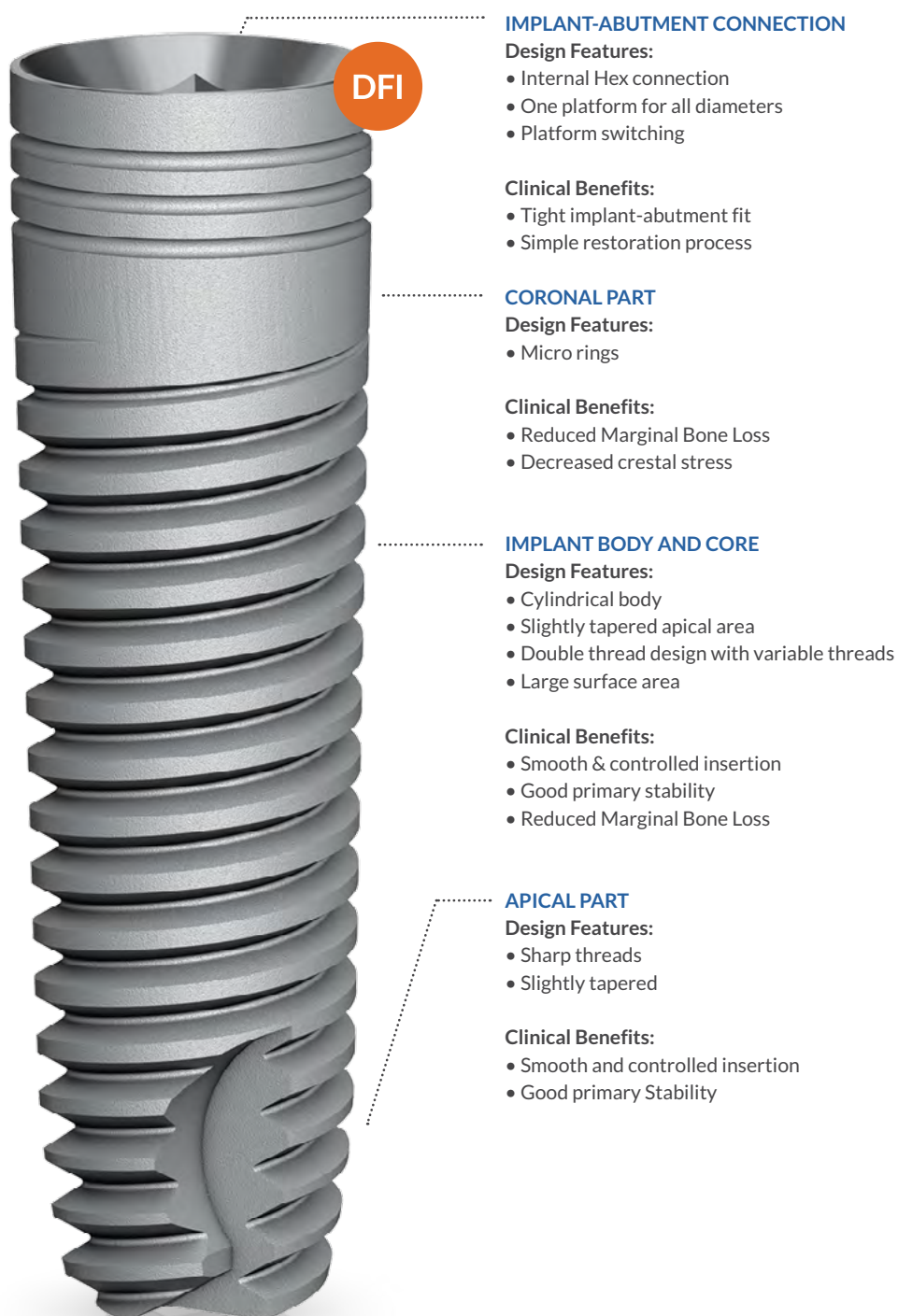

IMPLANT-ABUTMENT CONNECTION

Design Features:

- Internal Hex connection
- One platform for all diameters
- Platform switching

Clinical Benefits:

- Tight implant-abutment fit
- Simple restoration process



CORONAL PART

Design Features:

- Micro rings

Clinical Benefits:

- Reduced Marginal Bone Loss
- Decreased crestal stress



IMPLANT BODY AND CORE

Design Features:

- Cylindrical body
- Slightly tapered apical area
- Double thread design with variable threads
- Large surface area

Clinical Benefits:

- Smooth & controlled insertion
- Good primary stability
- Reduced Marginal Bone Loss

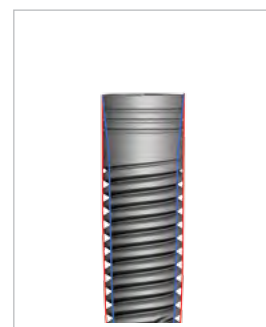

APICAL PART

Design Features:

- Sharp threads
- Slightly tapered

Clinical Benefits:

- Smooth and controlled insertion
- Good primary Stability



Note: The illustration shows DFI implant $\varnothing 3.3 / 13$ mm

Important: Professional considerations may be required for adaptations of the drill protocol in specific cases.

Wide range of narrow, standard and wide healing abutments.



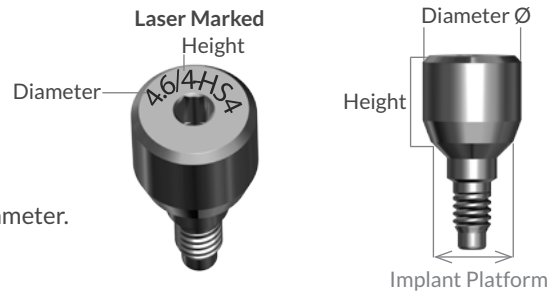

- Used for Internal Hex implants.
- Polished titanium surface for tissue acceptance.
- Laser marking to ensure easy identification of height and diameter.

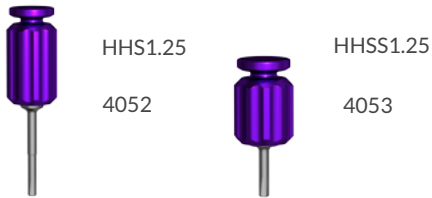

Manual Tightening

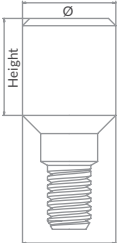

TITANIUM HEALING ABUTMENTS

 <p>Plate-forme shifting</p>	Ø 3.85 mm		
			
Dimensions	D: Ø 3.85 mm H: 3 mm	D: Ø 3.85 mm H: 4 mm	D: Ø 3.85 mm H: 5 mm
Code	HSS3	HSS4	HSS5
Ref. No.	112	114	113
Instructions	Use 1.25 mm driver for insertion (Ref. No. 4052 or 4053)		



HEALING ABUTMENTS

TITANIUM HEALING ABUTMENTS

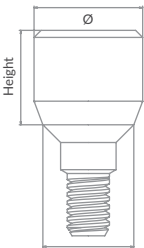

Ø 4.6 MM

Dimensions	D: Ø 4.6 mm H: 2 mm	D: Ø 4.6 mm H: 3 mm	D: Ø 4.6 mm H: 4 mm	D: Ø 4.6 mm H: 5 mm	D: Ø 4.6 mm H: 6 mm	D: Ø 4.6 mm H: 7 mm
Code	HS2	HS3	HS4	HS5	HS6	HS7
Ref. No.	116	109	117	110	118	119

WIDE TITANIUM HEALING ABUTMENTS

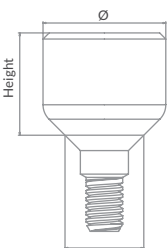

Ø 5 MM **Ø 5.5 MM**

Dimensions	D: Ø 5 mm H: 3 mm	D: Ø 5 mm H: 5 mm	D: Ø 5.5 mm H: 3 mm	D: Ø 5.5 mm H: 5 mm
Code	HS5-3	HS5-5	HS5.5-3	HS5.5-5
Ref. No.	124	125	126	127

WIDE TITANIUM HEALING ABUTMENTS

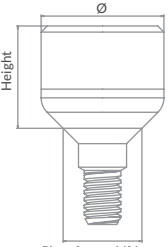

Ø 6 MM **Ø 7 MM**

Dimensions	D: Ø 6 mm H: 3 mm	D: Ø 6 mm H: 5 mm	D: Ø 7 mm H: 3 mm
Code	HS6-3	HS6-5	HS7-3
Ref. No.	128	129	130

CLOSED TRAY TRANSFER

EACH TRANSFER IS SUPPLIED WITH ITS CORRESPONDING SCREW.

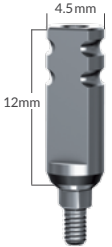
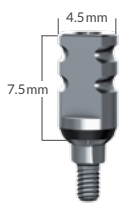
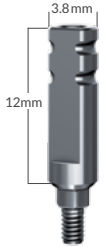
	STANDARD	SHORT	SLIM
			
Material	Stainless steel		Stainless steel
Code	HLT	HLTS	HLTLS
Ref. No.	5060	5170	5062
Instructions	Use 1.25 mm driver for insertion (Ref. No. 4052 or 4053). Manual tightening.		

CLOSED TRAY IMPRESSION

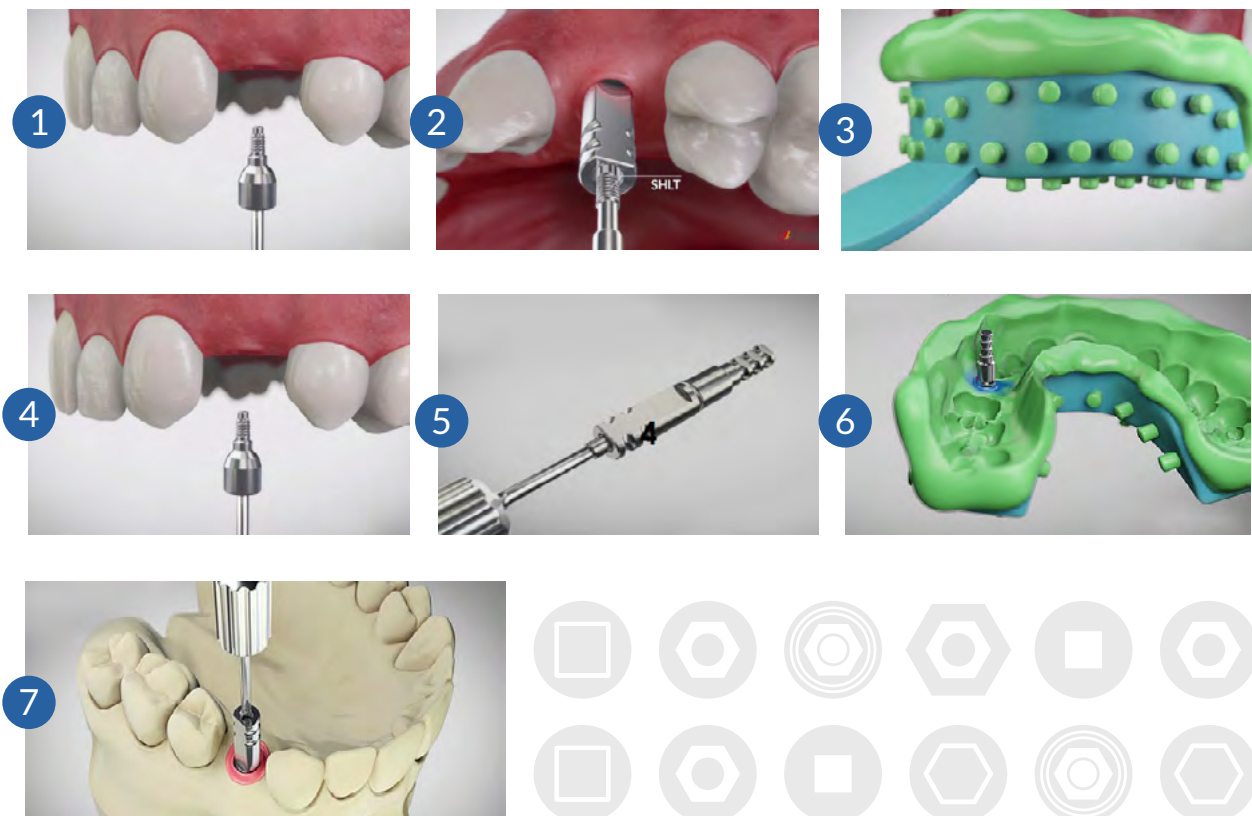

IMPLANT IMPRESSION

OPEN TRAY TRANSFER

EACH TRANSFER IS SUPPLIED WITH ITS CORRESPONDING SCREW.

	STANDARD	SHORT
Material	Stainless steel	
Code	HLTO	HLTOS
Ref. No.	5061	5171
Instructions	Use 1.25 mm driver for insertion (Ref. No. 4052 or 4053). Manual tightening.	

OPEN TRAY IMPRESSION

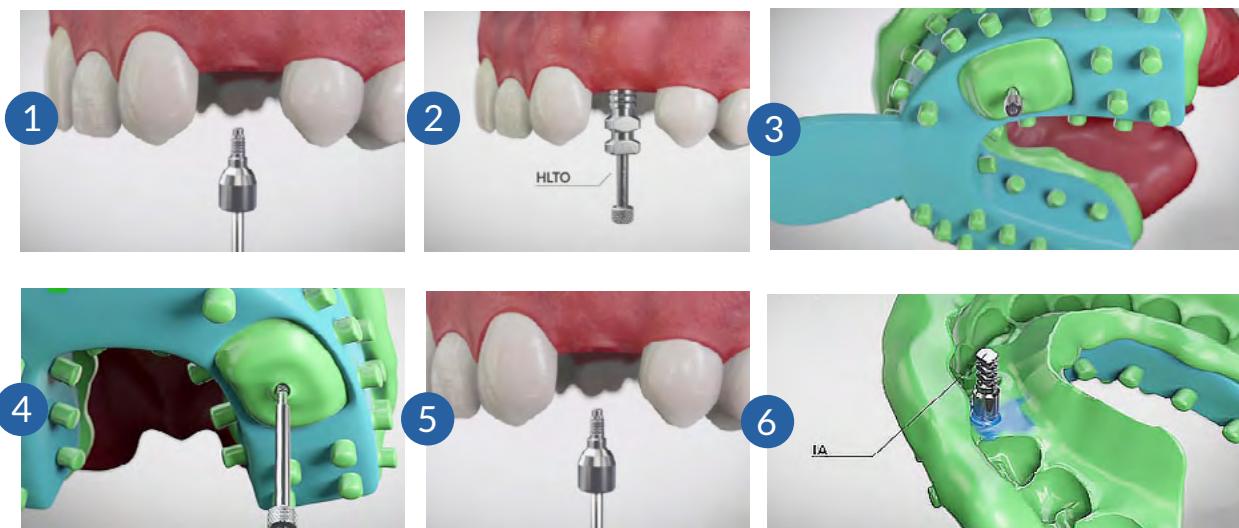



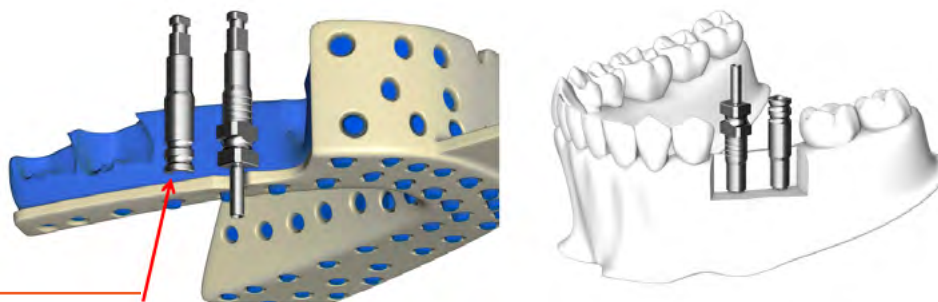

IMPRESSION





Before taking the impression, attach the transfer to the implant with the flat surface facing the buccal area.



TITANIUM ABUTMENTS

	STRAIGHT ABUTMENTS		SLIM ABUTMENTS	
				
Dimensions	A: Ø4.5 mm B: 1.7 mm C: 8.5 mm	A: Ø4.5 mm B: 1.7 mm C: 12.5 mm	A: Ø3.85 mm B: 0.8 mm C: 8.5 mm	A: Ø3.85 mm B: 0.5 mm C: 8.5 mm
Code	TLA	TLAL	TLAS	TLASSP
Ref. No.	5030	5140	5150	5403
Instructions	Use 1.25 mm driver for insertion (see page 27).			

30
NCM

	STRAIGHT ABUTMENTS WITH VARIOUS CUFF HEIGHTS				PLASTIC TRANSFER
					
Dimensions	A: Ø4.8 mm B: 1 mm C: 8.9 mm	A: Ø4.8 mm B: 2 mm C: 9.9 mm	A: Ø4.8 mm B: 3 mm C: 10.9 mm	A: Ø4.8 mm B: 4 mm C: 11.9 mm	7.1mm 10mm 6mm Ø5.5mm
Code	TLASP1	TLASP2	TLASP3	TLASP4	HTLASP
Ref. No.	5366	5367	5368	5369	5364
Instructions	Use 1.25 mm driver for insertion (see page 27)				Suitable or TLASP and ETLASP abutments

30
NCM

Measure the height of the soft tissue and choose the appropriate abutment

- Position the abutment in the implant, if possible with the flat surface facing the buccal area.
- Screw the abutment manually into the implant

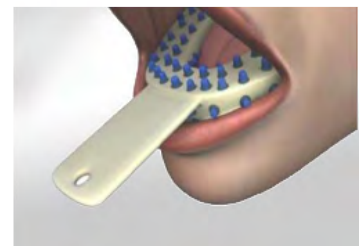
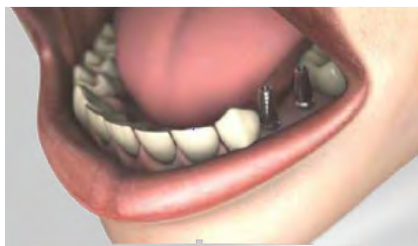
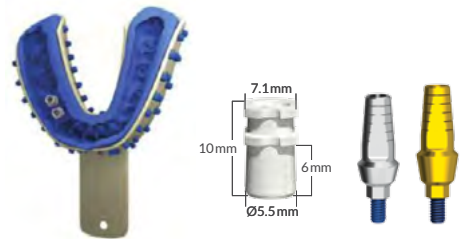

- Position the plastic transfer on the abutment
- Press down on the plastic transfer cap

- A "click" indicates that the transfer is correctly positioned
- Take the impression
- Send the impression to the lab with the analog

CEMENT-RETAINED RESTORATIONS

WIDE TITANIUM ABUTMENTS

WIDE PROFILE ABUTMENTS		WIDE PROFILE ABUTMENTS 30 NCM	
Dimensions	A: Ø5.6 mm B: 2 mm C: 9.5 mm	A: Ø5.6 mm B: 4 mm C: 11.5 mm	Dimensions A: Ø4.5 mm C: 8.5 mm
Code	TLAO2	TLAO4	Code TLAW
Ref. No.	5182	5362	Ref. No. 5340
Instructions	For wide emergence profile restorations and more flexibility of abutment fabrication/customization		Instructions For wide emergence profile restorations & more flexibility of abutment fabrication/customization

ANGLED TITANIUM ABUTMENTS

ANGLED ABUTMENTS 15° 30 NCM			
Dimensions	A: 1.7 mm B: 0.5 mm C: 8.5 mm D: 4.5 mm	A: 1.65 mm B: 0.15 mm C: 11.5 mm D: 4.5 mm	A: 2.3 mm B: 1 mm C: 8.5 mm D: 4.7 mm
Code	TLA 15	TLAL 15	TLA 15BB
Ref. No.	5090	5092	5098
Instructions	For creation of favorable line of insertion		

ANGLED ABUTMENTS 25°		ANGLED ABUTMENTS 35°
Dimensions	A: 1.8 mm B: 0.4 mm C: 8.5 mm D: 4.7 mm	A: 2.4 mm B: 0.4 mm C: 11.5 mm D: 4.4 mm
Code	TLA 25	TLA 35
Ref. No.	5130	5136
Instructions	For creation of favorable line of insertion	Use screw Ref. No. 5127

TEMPORARY PEEK ABUTMENT



- Vital for 180 days
- PEEK polymer allows easy and quick chair-side modification
- Biocompatible
- Provides adequate strength to the provisional restoration
- High resistance to repetitive mastication forces
- Suitable able for cement-retained or screw-retained temporary restoration



TEMPORARY PEEK STRAIGHT ABUTMENTS

Dimensions	L: 9 mm, H: 1mm	L: 9 mm, H: 2mm	L: 9 mm, H: 3mm
Code	TPA1	TPA2	TPA3
Ref. No.	5416	5417	5418

TEMPORARY PEEK ANGLED ABUTMENTS

	15°			25°	
Dimensions	L: 8 mm, H: 1mm	L: 8 mm, H: 2mm	L: 8 mm, H: 3mm	L: 8 mm, H: 1mm	L: 8 mm, H: 2mm
Code	TPA15-1	TPA15-2	TPA15-3	TPA25-1	TPA25-2
Ref. No.	5419	5420	5421	5422	5423



TEMPORARY TITANIUM ABUTMENTS

TEMPORARY TITANIUM ABUTMENTS

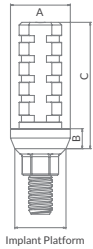

TEMPORARY ABUTMENTS



Dimensions	A: Ø4.5 mm B: 1.7 mm C: 9.5 mm	A: Ø4.5 mm B: 1.7 mm C: 7.8 mm
Code	TLAC-AR	TLAC-R Non-Engaging
Ref. No.	5200	5220
Instructions		Used for multiple unit restorations

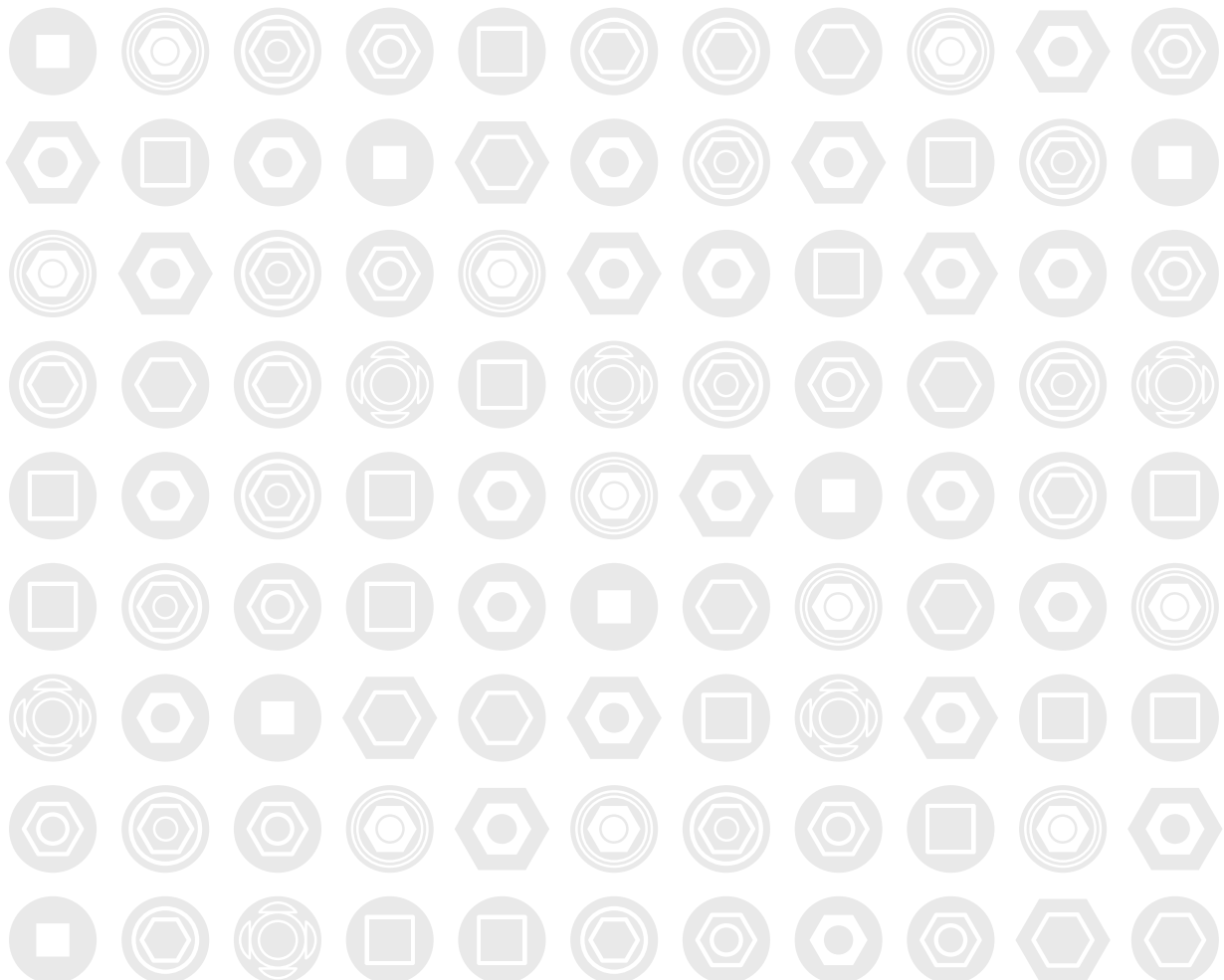

ESTHETIC TITANIUM ABUTMENTS



30
NCM

	STRAIGHT ABUTMENTS WITH VARIOUS CUFF HEIGHTS				PLASTIC TRANSFER
Dimensions	A: Ø4.5 mm B: 1 mm C: 7.5 mm	A: Ø3.9 mm B: 2 mm C: 9.9 mm	A: Ø4.5 mm B: 3 mm C: 10.5 mm	A: Ø4.5 mm B: 4 mm C: 11.5 mm	
Code	ETLASP1	ETLASP2	ETLASP3	ETLASP4	HTLASP
Ref. No.	5352	5353	5354	5355	5364
Instructions	Use 1.25 mm driver for insertion (see page 27)				Suitable or TLASP & ETLASP abutments

	STRAIGHT ABUTMENTS		ANGLED ABUTMENTS		
Dimensions	A: Ø4.5 mm 1.7 mm / 8.5 mm	A: Ø3.85 mm 0.8 mm / 8.5 mm	A: Ø1.65 mm B: 0.15 mm C: 11.5 mm D: 4.5 mm		A: Ø1.8 mm B: 0.4 mm C: 8.5 mm D: 4.7 mm
Code	ETLA	ETLAS	ETLAL 15		ETLAL 25
Ref. No.	5031	5155	5094		5131

	ANGLED ABUTMENTS 15°			ANGLED ABUTMENTS 25°		
Dimensions	A: 1.6 mm B: 2.5 mm C: 8.7 mm D: 5.1 mm	A: 2.6 mm B: 3.5 mm C: 9.7 mm D: 5.1 mm	A: 3.6 mm B: 4.5 mm C: 10.6 mm D: 5.1 mm	A: 1.6 mm B: 2.3 mm C: 9 mm D: 5.3 mm	A: 2.5 mm B: 3.3 mm C: 9.9 mm D: 5.3 mm	A: 3.7 mm B: 4.5 mm C: 10.9 mm D: 5.3 mm
Code	EAAS 15	EAA 15	EAAH 15	EAAS 25	EAA 25	EAAH 25
Ref. No.	5410	5411	5412	5413	5414	5415
Instructions	Designed especially for pre-molars and molars			Designed especially for pre-molars and molars		

CASTING ABUTMENTS

CoCr BASE ABUTMENTS

- Cobalt-Chrome Base
- Plastic casting sleeve from Polyethylene Delrin

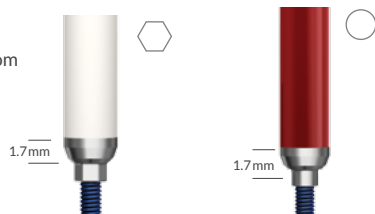

Code	TLABCC	TLABCC-R
Ref. No.	6405	6406
Instructions	Melting Range: 1200°C - 1330°C Recommended sintering below 900°C	

PLASTIC ABUTMENT FOR CASTING

30
NCM

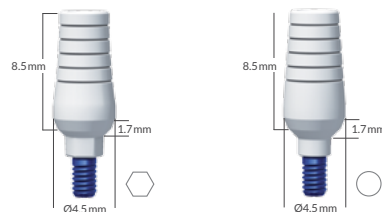

Code	PLA	PLA-R
Ref. No.	5040	5041

IMPLANT ANALOGS

Implant analog (IA) is suitable for all implant diameters (Ø3.3, Ø3.75, Ø3.75, Ø4.2, Ø5.0, Ø6.0 mm).

When using Ø5.0 mm or Ø6.0 mm implants, it is recommended to use lab analogs of identical dimensions, i.e. IA5 and IA6.

	STANDARD	WIDE	MULTI-UNIT	PRINTED MODEL
Code	IA	IA5	BTT-N	AN-PM
Ref. No.	5080	5280	5211	4995
Instructions	* IA5 is not compatible with ICE implants. Use 1.25 mm driver for insertion (Ref. No. 4052 or 4053).		For Multi-Unit restorations	For resin printed models

SCREWS

PROSTHETIC SCREWS

30
NCM



RETRIEVAL SCREW



Code	STLAS	STLAT*	STLASH**	RS
Ref. No.	5122	5121	5127	5110
Instructions	* Specially coated, for laboratory use only. ** To be used only with the TLA36 abutment. Ref. 5136 (Page 49)			Fits IH and CS platforms.

SCREW-RETAINED RESTORATIONS

MULTI-UNIT ABUTMENTS

ANGLED ABUTMENTS	IMPLANTS	STRAIGHT ABUTMENTS	OPEN TRAY TRANSFER	CLOSED TRAY
 <p>5432 AU 17-1.5 IH A: Ø 4.7 B: 1.5 mm</p>	   	 <p>5221 TCT0.5-N A: Ø4.7 mm B: 0.75 mm C: 1 mm</p>	   <p>5231 TST-N 5248 TCT-N-R 5235 TS-N</p>	
 <p>5433 AU 17-2.5 IH A: Ø 4.7 B: 2.5 mm</p>		 <p>5222 TCT1.5-N A: Ø4.7 mm B: 1.6 mm C: 2.8 mm</p>	 <p>5211 BTT-N</p>	
 <p>5434 AU 17-3.5 IH A: Ø 4.7 B: 3.5 mm</p>		 <p>5223 TCT2.5-N A: Ø4.7 mm B: 2.6 mm C: 3.8 mm</p>	<p>ANALOG</p>	
 <p>5437 AU 30-1.5 IH A: Ø 4.7 B: 1.5 mm</p>		 <p>5252 TCT3.5-N A: Ø4.7 mm B: 3.6 mm C: 4.8 mm</p>	<p>FIXATION SCREW</p>   <p>6092 SF-N 6093 SFT-N</p>	
 <p>5438 AU 30-2.5 IH A: Ø 4.7 B: 2.5 mm</p>		 <p>5253 TCT4.5-N A: Ø4.7 mm B: 4.6 mm C: 5.8 mm</p>	<p>TEMPORARY ABUTMENT</p>  <p>5216 TTA-N</p> <p>Includes screw 6092.</p>	
 <p>5439 AU 30-3.5 IH A: Ø 4.7 B: 3.5 mm</p>		 <p>5254 TCT5.5-N A: Ø4.7 mm B: 5.6 mm C: 6.8 mm</p>	<p>PRO HEALING ABUTMENTS</p>   <p>5236 HCT4-N 5237 HCT6-N</p> <p>Integrated screw</p>	
 <p>4055 1.25 mm</p>		 <p>4057 1.5 mm</p>	<p>BURNOUT SLEEVE</p>   <p>5217 PST-N-AR 5218 PST-N</p> <p>includes screw 6093.</p>	
<p>1.25 MM DRIVER</p>		<p>1.5 MM DRIVER</p>		
 <p>4052 HHS 1.25 4053 HHSS 1.25 4061 HTD 1.25 L 4055 HTD 1.25 4056 HTD 1.25 S 4165 HTD 1.25 M</p>		 <p>4059 HHS 1.5 4060 HHL 1.5 4057 HTD 1.5 4058 HTD 1.5 S 4168 HT 1.5</p>		

TORQUE

4572
TORQUE RATCHET



Straight Multi-Unit abutment	30 Ncm
Impression transfer and healing abutment	Manual Tightening
Temporary fixture	25 Ncm
Angled Multi-Unit abutment	30 Ncm











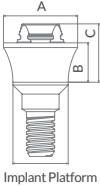



SCREW-RETAINED RESTORATIONS



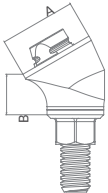



MULTI-UNIT ABUTMENTS

30 NCM

	MULTI-UNIT STRAIGHT ABUTMENTS					
						
Dimensions	A: Ø4.7 mm B: 0.75 mm C: 1 mm	A: Ø4.7 mm B: 1.6 mm C: 2.8 mm	A: Ø4.7 mm B: 2.6 mm C: 3.8 mm	A: Ø4.7 mm B: 3.6 mm C: 4.8 mm	A: Ø4.7 mm B: 4.6 mm C: 5.8 mm	A: Ø4.7 mm B: 5.6 mm C: 6.8 mm
Code	TCT0.5-N	TCT1.5-N	TCT2.5-N	TCT3.5-N	TCT4.5-N	TCT5.5-N
Ref. No.	5221	5222	5223	5252	5253	5254

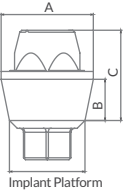
	MULTI-UNIT ANGLED ABUTMENTS					
						
Angle	17°			30°		
Dimensions	A: Ø 4.7 B: 1.5 mm	A: Ø 4.7 B: 2.5 mm	A: Ø 4.7 B: 3.5 mm	A: Ø 4.7 B: 1.5 mm	A: Ø 4.7 B: 2.5 mm	A: Ø 4.7 B: 3.5 mm
Code	AU 17-1.5 IH	AU 17-2.5 IH	AU 17-3.5 IH	AU 30-1.5 IH	AU 30-2.5 IH	AU 30-3.5 IH
Ref. No.	5432	5433	5434	5437	5438	5439



HBC ABUTMENTS

	STRAIGHT ABUTMENTS - FOR SINGLE IMPLANT RESTORATION			
				
Dimensions	A: Ø4.7 mm B: 0.5mm C: 2.6mm	A: Ø4.7 mm B: 1.5mm C: 3.6mm	A: Ø4.7 mm B: 2.5mm C: 4.6mm	
Code	HBC 0.5	HBC 1.5	HBC 2.5	
Ref. No.	6040	6041	6042	





Note: Package includes HBC abutment screw and burn-out sleeve.

	DUAL USE SCAN BODIES FOR MULTI-UNITS		ADHESIVE COPINGS FOR MULTI-UNITS	
			Engaged 	Non-engaged 
Height	7 mm	7 mm	3.5 mm	3.5 mm
Code	IOSB-TCT-N-R	IOSB-TCT-N	TAC-TCT-N	TAC-TCT-N-R
Ref. No.	3883*	5003*	5028 	5029 
Instructions	For bridge/bar restorations with multi-unit straight and angled abutments	For single crown restorations with multi-unit angled abutments	For single tooth restorations	For bar/bridge restorations

* Screw included.

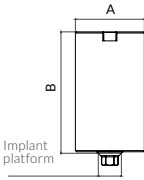
SCREWS			
			
Code	SF-N	SFT-N	S-DM-SR
Ref. No.	6092	6093	4994
Instructions	Fixation screw for Multi-Unit restoration	Black coated screw for Lab	Direct mounting on metal frame*

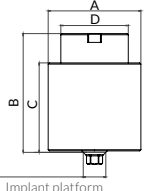
* Should not be used for full zirconia or ceramic restorations.

PRE-MILLED BLANKS				ANALOG
				
Dimensions	A: Ø11.5 mm B: 20.2 mm	Dimensions	A: Ø15.8 mm B: 20.25 mm C: 15.25 mm D: Ø11.5 mm	
Code	BA-PF-IH	Code	WBA-PF-IH	AN-PM
Ref. No.	4988	Ref. No.	4989	4995
Instructions	For Preface® abutment holder. Screw included			For resin printed models

CAD/CAM RESTORATION PARTS

DUAL USE SCAN BODY



HEIGHT	10 mm
CODE	SB-IH
REF. NO.	5019

Manual Tightening

Use 1.25 mm driver for insertion (see page 27)

30 NCM

	TI-BASES				WIDE TI-BASES	
	Engaged		Non-engaged		Engaged	Non-engaged
<p>Implant platform</p>						
Gingival Height	0.7 mm	2.5 mm	0.7 mm	2.5 mm	0.7 mm	0.7 mm
Dimensions	A: Ø4.5 mm B: 5 mm C: 5.7 mm D: 0.6 mm	A: Ø4.5 mm B: 4 mm C: 6.5 mm D: 0.6 mm	A: Ø4.5 mm B: 5 mm C: 5.7 mm D: 0.7 mm	A: Ø4.5 mm B: 4 mm C: 6.5 mm D: 0.7 mm	A: Ø6 mm B: 3.5 mm C: 4.2 mm D: 1.2 mm	A: Ø6 mm B: 3.5 mm C: 4.2 mm D: 1.43 mm
Code	CCTB ◻	CCTB-2.5 ◻	CCTB-R ○	CCTB-R-2.5 ○	WCCTB ◻	WCCTB-R ○
Ref. No.	5024	4951	5025	4952	5007	5008



Screw included.

SIRONA COMPATIBLE



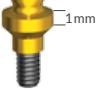
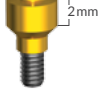
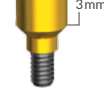
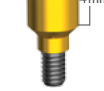

	TI-BASE	SCAN POST
Code	CCTB-IH-SI	CCSP-IH-SI
Ref. No.	4980	4984
Instructions	For scanning and/or restoration use	For scanning only

Screw included.







ALPHALOC ABUTMENT SYSTEM

ALPHALOC						
						
Height	0.5 mm	1 mm	2 mm	3 mm	4 mm	5 mm
	4867	4868	4869	4870	4871	4872
Dimensions	A: Ø 2.5 mm B: 0.5 mm C: 2.16 mm	A: Ø 2.5 mm B: 1 mm C: 2.66 mm	A: Ø 2.5 mm B: 2 mm C: 3.66 mm	A: Ø 2.5 mm B: 3 mm C: 4.66 mm	A: Ø 2.5 mm B: 4 mm C: 5.66 mm	A: Ø 2.5 mm B: 5 mm C: 6.66 mm

Kit includes: 1 AlphaLoc abutment of the given height, 1 stainless steel metal housing, 4 retentive caps, 1 block-out spacer, 1 laboratory cap

	ALPHALOC PROCESSING PACKAGE	ALPHALOC RETENTIVE CAPS			
					
Ref. No.	4875	4876	4877	4878	4879
Includes	Stainless steel metal housing, block-out spacer, nylon retentive caps (violet, clear, pink and yellow), laboratory cap (black)	Violet (strong retention)	Clear (standard retention)	Pink (soft retention)	Yellow (extra soft retention)
		4 units per package			

ALPHALOC ACCESSORIES

	LABORATORY CAP (BLACK)	BLOCK OUT SPACER	IMPRESSION COPING	MALE ANALOG	INSERTION TOOL *	EXTRACTION TOOL *
						
Content	4 Units	1 Unit	4 Units	4 Units	1 Unit	1 Unit
Ref. No.	4882	4883	4884	4885	4886*	4887*

* In some markets, the insertion and extraction tool is provided as a single, dual sided instrument.

TITANIUM BALL ATTACHMENTS

The ball attachments are used for tissue and implant-supported overdentures, typically with two or more parallel implants (within 10°). Ball attachments provide firm retention and stabilization to the overdenture. Make sure a proper tissue support for the prosthesis is available.



STRAIGHT BALL ATTACHMENTS						
Code	TB 0.5	TB 2	TB 3	TB 4	TB 5	TB 6
Ref. No.	6260	6210	6280	6220	6270	6290
Instructions	For impression, use analog 5080 and IH transfers. Use 1.25 driver for insertion (see page 27). Use nylon cap \varnothing 2.5 mm.					

ANGLED BALL ATTACHMENTS	
Code	TBAA2
Ref. No.	6304
Code	TBAA3
Ref. No.	6306
Instructions	Ball is oriented to the flat surface of the hex

NYLON CAP FOR \varnothing 2.5 MM			
	Stainless steel Housing	Nylon Cap	Nylon Cap with Titanium Ring
Code	H	NC	NCT
Ref. No.	6240	6250	6251
			Soft Nylon Cap
Code			NCA
Ref. No.			6253













Conical Narrow Connection (CHC)

The Conical Narrow Connection system includes 3.2 and 3.5 mm implant diameters with a conical narrow connection for cases involving narrow ridges and limited-space between adjacent teeth. It is compatible with Alpha-Bio Tec's CHC prosthetic line and CAD/CAM restoration parts.



Ø3.2, Ø3.5





CONNECTION	 CONICAL NARROW CONNECTION	 CONICAL NARROW CONNECTION
	Active implant designed for immediate implant procedures in narrow ridges and limited spaces.	An Extended Solution for Narrow Ridges
RECOMMENDED BONE TYPE	   	   
DESIGN FEATURES	<ul style="list-style-type: none"> • Tapered • Centering and anchoring features • Double, variable threads • Micro-threads 	<ul style="list-style-type: none"> • Moderately tapered • Split coronal micro threads
CLINICAL BENEFITS	<ul style="list-style-type: none"> • High primary stability • Reduced marginal bone loss • Increased surface area • Increased BIC 	<ul style="list-style-type: none"> • Improved stress distribution • Supports wide range of clinical cases • Controlled bone penetration
	OPTIMAL	NARROW IMPLANT



MULTINEO™ MULTIPLE OPTIONS

RECOMMENDED BONE TYPE			
DESIGN FEATURES	<ul style="list-style-type: none"> • Tapered • Centering and anchoring features • Double, variable threads • Micro-threads 	CLINICAL BENEFITS	<ul style="list-style-type: none"> • High primary stability • Reduced marginal bone loss • Increased surface area • Increased BIC



Ø Diameter	Length	Ref. No.	Dimensions				
			A	B	C	D	H
 Ø 3.2	8 mm	1908	Ø 3.2	Ø 2.9	Ø 1.5	Ø 2.5	Ø 2.1
	10 mm	1900	Ø 3.2	Ø 2.9	Ø 1.5	Ø 2.5	Ø 2.1
	11.5 mm	1901	Ø 3.2	Ø 2.9	Ø 1.5	Ø 2.5	Ø 2.1
	13 mm	1903	Ø 3.2	Ø 2.9	Ø 1.5	Ø 2.5	Ø 2.1
	16 mm	1906	Ø 3.2	Ø 2.9	Ø 1.5	Ø 2.5	Ø 2.1
 Ø 3.5	8 mm	1928	Ø 3.5	Ø 2.9	Ø 1.5	Ø 2.5	Ø 2.1
	10 mm	1920	Ø 3.5	Ø 2.9	Ø 1.5	Ø 2.5	Ø 2.1
	11.5 mm	1921	Ø 3.5	Ø 2.9	Ø 1.5	Ø 2.5	Ø 2.1
	13 mm	1923	Ø 3.5	Ø 2.9	Ø 1.5	Ø 2.5	Ø 2.1
	16 mm	1926	Ø 3.5	Ø 2.9	Ø 1.5	Ø 2.5	Ø 2.1

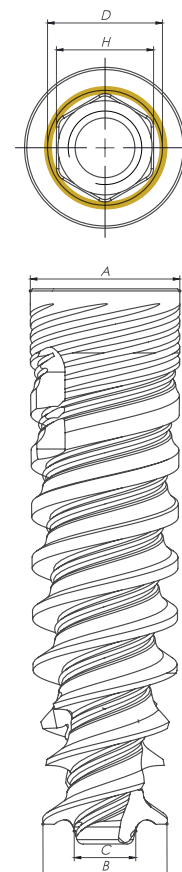

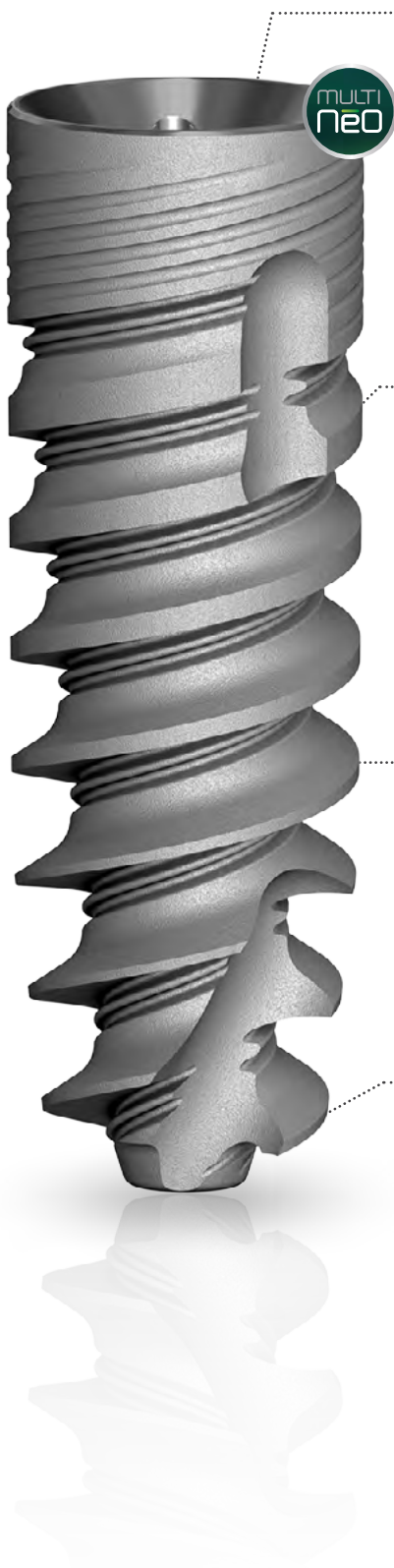

CORONAL PART

Design Features:

- Platform Switching
- Micro-threads
- Cutting flutes
- Conical narrow connection

Clinical Benefits:

- Reduced pressure on cortical area
- Efficient cutting ability
- Improved bone preservation
- High initial stability

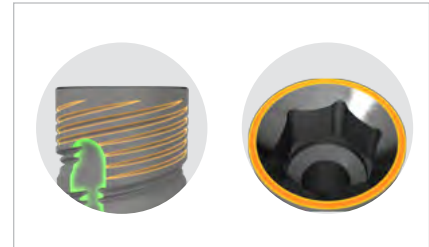

IMPLANT THREADS

Design Features:

- Variable thread design
- Double thread with 2.4 mm step
- Micro-threads

Clinical Benefits:

- High cutting efficiency
- Osteotome like body
- Fast and controlled insertion
- Increased surface area
- Increased BIC

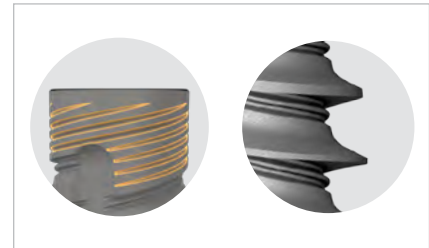

IMPLANT BODY AND CORE

Design Features:

- Straight coronal part
- Slightly tapered body
- Tapered core
- Tapered apical part

Clinical Benefits:

- Osteotome like body
- High primary stability

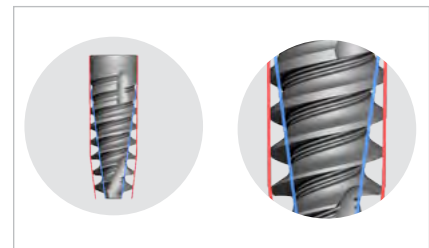

APICAL PART

Design Features:

- Narrow apex
- Sharp and deep threads
- Patented centering feature

Clinical Benefits:

- High primary stability
- Easy navigation and penetration
- Efficient cutting capability

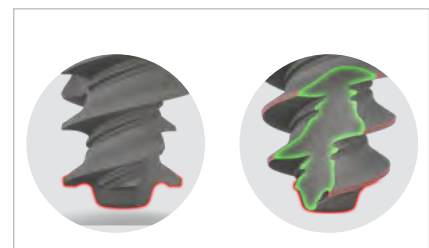

IMPLANT SYSTEM

IMPLANT PACKAGE

A modern and easy-to-use implant package with enhanced ergonomics.





DRIVERS

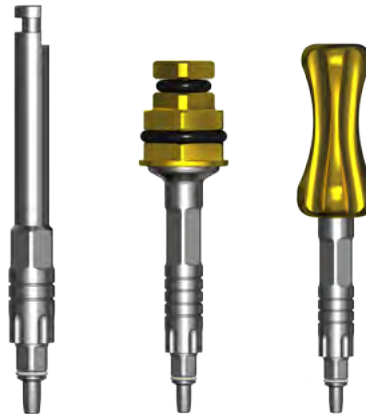

Color coded grip drivers with gingival height markings and lead pin for centering and easy insertion.



STEP DRILLING SEQUENCE

	Bone Type IV		Bone Type II & III			Bone Type I			
Ø 3.2	Ø 2.0		Ø 2.0	Ø 2.4/Ø 2.8		Ø 2.0	Ø 2.4/Ø 2.8	Ø 2.8/Ø 3.0	
Ø 3.5	Ø 2.0	Ø 2.0/Ø 2.4	Ø 2.0	Ø 2.4/Ø 2.8	Ø 2.8/Ø 3.0	Ø 2.0	Ø 2.4/Ø 2.8	Ø 2.8/Ø 3.2	

STRAIGHT DRILLING SEQUENCE

	Bone Type IV		Bone Type II & III			Bone Type I			
Ø 3.2	Ø 2.0		Ø 2.0	Ø 2.4	Ø 2.8*	Ø 2.0	Ø 2.8	Ø 3.0*	
Ø 3.5	Ø 2.0	Ø 2.4*	Ø 2.0	Ø 2.8	Ø 3.0*	Ø 2.0	Ø 2.8	Ø 3.2*	

* 3mm shorter than implant's length.

Important: Professional considerations may be required for adaptations of the drill protocol in specific cases.

MULTINEO™

ONE IMPLANT **MULTIPLE OPTIONS**

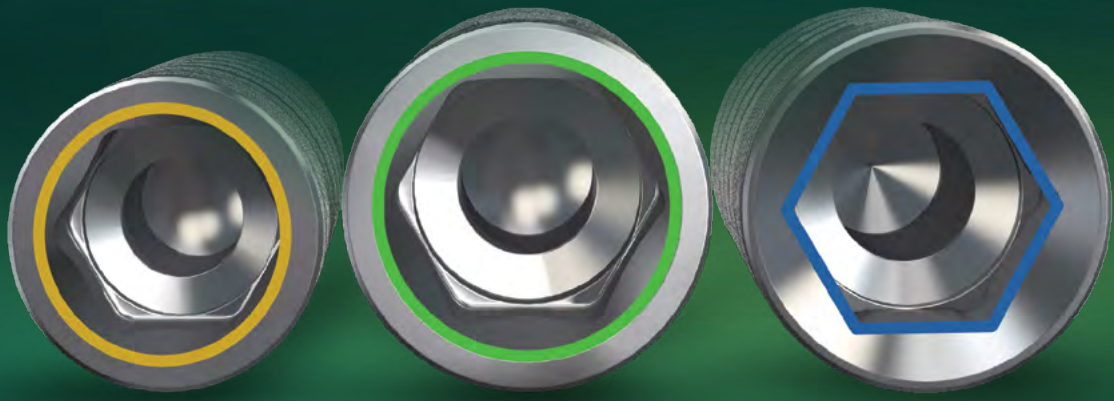

The Complete MULTINEO™ Implant Family

With more options to choose from, the MultiNeO™ family now includes 3 connections:



**Conical Narrow
Connection (CHC)**



**Conical Standard
Connection (CS)**



**Internal Hex
Connection (IH)**

Each connection features a dedicated restoration line

NICE SYSTEM AN EXTENDED SOLUTION FOR NARROW RIDGES

RECOMMENDED BONE TYPE



DESIGN FEATURES

- Moderately tapered
- Split coronal micro threads

CLINICAL BENEFITS





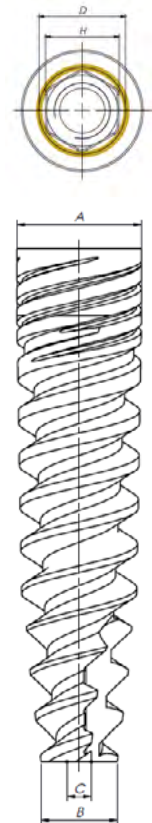

- Improved stress distribution
- Supports wide range of clinical cases
- Controlled bone penetration



Ø Diameter	Length	Ref. No.	Dimensions				
			A	B	C	D	H
 Ø 3.2	8 mm	1068	Ø 3.2	Ø 2.2	Ø 1.1	Ø 2.5	Ø 2.1
	10 mm	1060	Ø 3.2	Ø 2.0	Ø 1.1	Ø 2.5	Ø 2.1
	11.5 mm	1061	Ø 3.2	Ø 2.0	Ø 1.1	Ø 2.5	Ø 2.1
	13 mm	1063	Ø 3.2	Ø 2.0	Ø 1.1	Ø 2.5	Ø 2.1
	16 mm	1066	Ø 3.2	Ø 2.0	Ø 1.1	Ø 2.5	Ø 2.1



STRAIGHT DRILLING SEQUENCE

Bone Type IV	Bone Type II & III			Bone Type I		
Ø 2.0 	Ø 2.0 	Ø 2.8 	*	Ø 2.0 	Ø 2.8 	Ø 3.0** 



* In cases of thick cortical layer use 3.0 mm drill only through the cortex.

** 3 mm shorter than implant's length.

Important: Professional considerations may be required for adaptations of the drill protocol in specific cases.

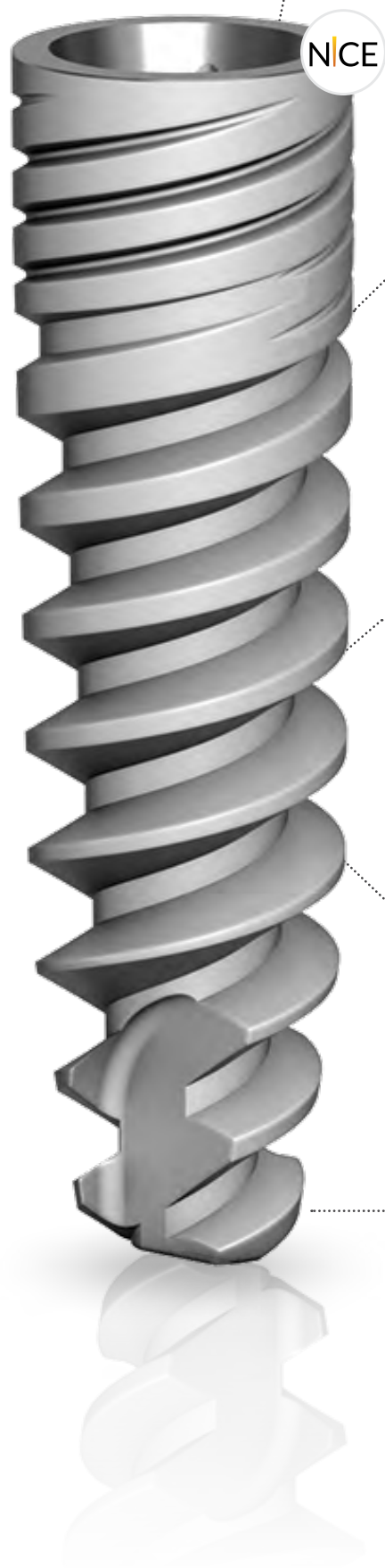

IMPLANT ABUTMENT CONNECTION

Design Features:

- Hex 2.1 mm
- Significant platform switching
- Tight implant abutment fit

Clinical Benefits:

- Low bacteria leakage
- Reduced micro movements
- Reduced marginal bone loss
- Esthetically pleasing results

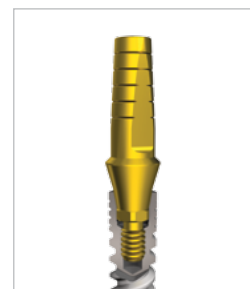

CORONAL PART

Design Features:

- Straight coronal part
- Split coronal micro-thread

Clinical Benefits:

- Increased surface area
- Increased BIC (Bone to Implant contact) in the coronal part
- Reduced marginal bone loss (MBL)
- Immediate and long-term esthetic results.



IMPLANT BODY AND CORE

Design Features:

- Tapered core and body
- Osteotome like body

Clinical Benefits:

- Smooth insertion to the bone
- High primary stability
- Enables immediate implantation and immediate loading

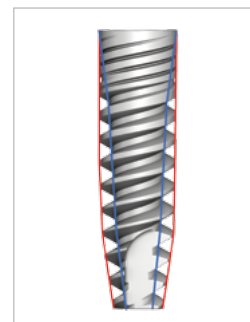

IMPLANT THREADS

Design Features:

- Double thread design 2.2 mm
- Variable thread design
- Trapezoid thread profile

Clinical Benefits:

- Narrow apical part 2.0mm
- Sharp and deep apical threads
- Tapered apex
- Flat apex



APICAL PART

Design Features:

- Narrow apical part 2.0mm
- Sharp and deep apical threads
- Tapered apex
- Flat apex

Advantages:

- Easy & controlled insertion
- High primary stability
- Suitable for immediate implantation and immediate loading

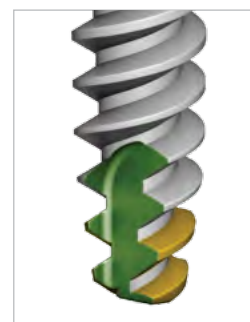

HEALING ABUTMENTS



Laser marking to ensure easy identification of height and diameter.

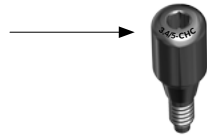

	Ø 3.4 mm			MANUAL TIGHTENING	
Dimensions	D: Ø 3.4 mm H: 2 mm	D: Ø 3.4 mm H: 3 mm	D: Ø 3.4 mm H: 5 mm		
Code	HSD3.4-2-CHC	HSD3.4-3-CHC	HSD3.4-5-CHC	HHS1.25	HHSS1.25
Ref. No.	7311	7312	7313	4052	4053

	Ø 3.8 mm		
Dimensions	D: Ø 3.8 mm H: 2 mm	D: Ø 3.8 mm H: 3 mm	D: Ø 3.8 mm H: 5 mm
Code	HSD3.8-2-CHC	HSD3.8-3-CHC	HSD3.8-5-CHC
Ref. No.	7315	7316	7317

	Ø 4.2 mm		
Dimensions	D: Ø 4.2 mm H: 2 mm	D: Ø 4.2 mm H: 3 mm	D: Ø 4.2 mm H: 5 mm
Code	HSD4.2-2-CHC	HSD4.2-3-CHC	HSD4.2-5-CHC
Ref. No.	7319	7320	7321

IMPRESSION TRANSFERS & ANALOGS

	CLOSED TRAY TRANSFER	OPEN TRAY TRANSFER
Code	HLTS-CHC	HLTO-CHC
Ref. No.	7333	7335
Instructions	Supplied with the screw. Max. 10 Ncm. Manual tightening.	

IMPLANT ANALOGS			
Code	IA-CHC	BTT-N	AN-PM-CHC
Ref. No.	7338	5211	4996
Instructions		For Multi-Unit restorations	For resin printed model

CEMENT-RETAINED RESTORATIONS









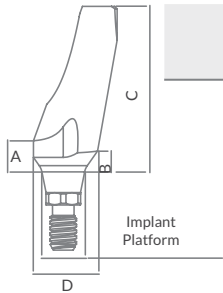

ESTHETIC STRAIGHT ABUTMENTS				
	20 NCM			
Dimensions	A: Ø 3.6 mm B: 1.0 mm C: 8.9 mm	A: Ø 3.6 mm B: 2.0 mm C: 9.9 mm	A: Ø 3.6 mm B: 3.0 mm C: 10.9 mm	A: Ø 3.6 mm B: 4.0 mm C: 11.9 mm
Code	ETLASP1-CHC	ETLASP2-CHC	ETLASP3-CHC	ETLASP4-CHC
Ref. No.	7350	7351	7352	7353
Instructions	Use 1.25 mm driver for insertion (see page 27). DO NOT exceed 20 Ncm.			



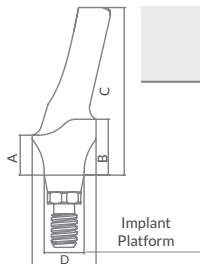

ESTHETIC STRAIGHT WIDE ABUTMENTS					
	20 NCM				
Dimensions	A: Ø 4.0 mm B: 1.0 mm C: 11.0 mm	A: Ø 4.0 mm B: 2.0 mm C: 12.0 mm	A: Ø 4.0 mm B: 3.0 mm C: 13.0 mm	A: Ø 4.0 mm B: 4.0 mm C: 14.0 mm	A: Ø 4.0 mm B: 5.0 mm C: 15.0 mm
Code	ETWASP1-CHC	ETWASP2-CHC	ETWASP3-CHC	ETWASP4-CHC	ETWASP5-CHC
Ref. No.	7370	7371	7372	7373	7374
Instructions	Use 1.25 mm driver for insertion (see page 27).				

ESTHETIC STANDARD ABUTMENTS				STANDARD ABUTMENT
	20 NCM			
Dimensions	A: Ø 3.2 mm C: 9.0 mm	A: Ø 3.6 mm C: 9.0 mm	A: Ø 4.0 mm C: 11.0 mm	A: Ø 4.0 mm C: 9.2 mm
Code	ETLAS3.2-CHC	ETLAS3.6-CHC	ETLAS4.0-CHC	TLAS4.0-CHC
Ref. No.	7356	7357	7383	7358
Instructions	Use 1.25 mm driver for insertion (see page 27).			

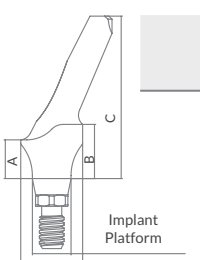

CEMENT-RETAINED RESTORATIONS



ESTHETIC ANGLED TITANIUM ABUTMENTS				
	20 NCM			
	 15°	 15°	 25°	
Dimensions	A: 1.1 mm B: 1.5 mm C: 8.2 mm D: Ø 3.9 mm	A: 1.1 mm B: 1.5 mm C: 10.2 mm D: Ø 3.9 mm	A: 1.1 mm B: 1.4 mm C: 8.2 mm D: Ø 4.3 mm	
Code	ETLA15-CHC	ETLAL15-CHC	ETLA25-CHC	
Ref. No.	7360	7361	7362	
Instructions	Use 1.25 mm driver for insertion (see page 27).			

ESTHETIC ANATOMIC 15° ANGLED ABUTMENTS				
	20 NCM			
	 15°	 15°	 15°	
Dimensions	A: 1.5 mm B: 2.5 mm C: 9.5 mm D: Ø 4.0 mm	A: 2.5 mm B: 3.5 mm C: 10.5 mm D: Ø 4.0 mm	A: 3.5 mm B: 4.5 mm C: 11.5 mm D: Ø 4.0 mm	
Code	EA15-1.5 CHC	EA15-2.5 CHC	EA15-3.5 CHC	
Ref. No.	7363	7364	7365	
Instructions	Use 1.25 mm driver for insertion (see page 27).			

ESTHETIC ANATOMIC 25° ANGLED ABUTMENTS				
	20 NCM			
	 25°	 25°	 25°	
Dimensions	A: 1.5 mm B: 2.5 mm C: 9.5 mm D: Ø 4.0 mm	A: 2.5 mm B: 3.5 mm C: 10.5 mm D: Ø 4.0 mm	A: 3.5 mm B: 4.5 mm C: 11.5 mm D: Ø 4.0 mm	
Code	EA25-1.5CHC	EA25-2.5CHC	EA25-3.5CHC	
Ref. No.	7366	7367	7368	
Instructions	Use 1.25 mm driver for insertion (see page 27).			

SCREWS

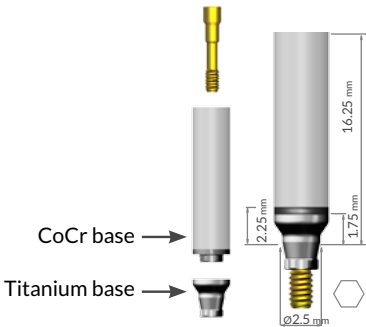
	PROSTHETIC SCREW CHC	RETRIEVAL SCREW CHC
		
Code	STLA-CHC	RS-CHC
Ref. No.	7345	7400

	CoCr BASE ABUTMENTS	SCREW
		 <div style="background-color: #FFD700; border-radius: 50%; padding: 5px; display: inline-block; font-weight: bold;">20 NCM</div>
Diameter	Ø 3.6	
Code	TLABCC-CHC	CCS-CHC
Ref. No.	3613	3616
Instructions	Melting Range: 1200°C - 1330°C. Recommended sintering below 900°C	

Note: Remove screw and titanium base before sintering



MULTINEO™

ONE IMPLANT **MULTIPLE OPTIONS**

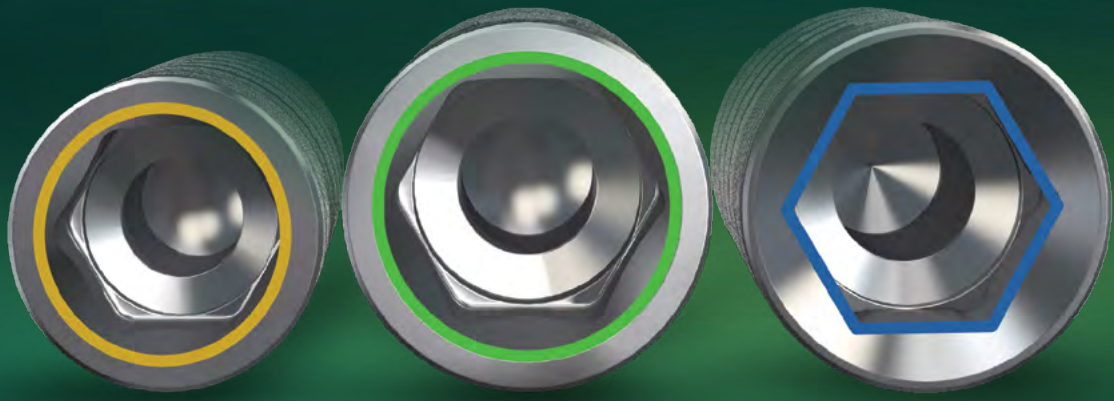

The Complete MULTINEO™ Implant Family

With more options to choose from, the MultiNeO™ family now includes 3 connections:



**Conical Narrow
Connection (CHC)**



**Conical Standard
Connection (CS)**



**Internal Hex
Connection (IH)**

Each connection features a dedicated restoration line

SCREW-RETAINED RESTORATIONS



ANGLED ABUTMENTS		IMPLANTS	STRAIGHT ABUTMENTS		OPEN TRAY TRANSFER	CLOSED TRAY
	7482 AU 17-1.5 CHC			A: Ø 4.7 mm B: 0.75 mm C: 1.95 mm		
	7483 AU 17-2.5 CHC	 		A: Ø 4.7 mm B: 1.5 mm C: 2.7 mm		
	7484 AU 17-3.5 CHC			A: Ø 4.7 mm B: 2.5 mm C: 3.7 mm	ANALOG	
	7487 AU 30-1.5 CHC			A: Ø 4.7 mm B: 3.5 mm C: 4.7 mm		
	7488 AU 30-2.5 CHC			A: Ø 4.7 mm B: 4.5 mm C: 5.7 mm	FIXATION SCREW	
	7489 AU 30-3.5 CHC			A: Ø 4.7 mm B: 5.5 mm C: 6.7 mm		
 1.25 MM DRIVER			 1.5 MM DRIVER		TEMPORARY ABUTMENT	
	4052 HHS 1.25					
	4053 HHSS 1.25				PRO HEALING ABUTMENTS	
	4061 HTD 1.25 L					
	4055 HTD 1.25					
	4056 HTD 1.25 S				Integrated screw	
	4165 HTD 1.25				BURNOUT SLEEVE	

TORQUE									
 4572 TORQUE RATCHET	<table border="1"> <tr> <td>Straight Multi- Unit Abutment CHC</td> <td>20 Ncm</td> </tr> <tr> <td>Impression transfer and healing abutment</td> <td>Manual Tightening</td> </tr> <tr> <td>Temporary fixture on MUA</td> <td>15 Ncm</td> </tr> <tr> <td>Angled Multi-Unit Abutment</td> <td>20 Ncm</td> </tr> </table>	Straight Multi- Unit Abutment CHC	20 Ncm	Impression transfer and healing abutment	Manual Tightening	Temporary fixture on MUA	15 Ncm	Angled Multi-Unit Abutment	20 Ncm
Straight Multi- Unit Abutment CHC	20 Ncm								
Impression transfer and healing abutment	Manual Tightening								
Temporary fixture on MUA	15 Ncm								
Angled Multi-Unit Abutment	20 Ncm								

SCREW-RETAINED RESTORATIONS

MULTI UNIT ABUTMENTS

20
NCM





	MULTI-UNIT STRAIGHT ABUTMENTS CHC					
Dimensions	A: Ø 4.7 mm B: 0.75 mm C: 1.95 mm	A: Ø 4.7 mm B: 1.5 mm C: 2.7 mm	A: Ø 4.7 mm B: 2.5 mm C: 3.7 mm	A: Ø 4.7 mm B: 3.5 mm C: 4.7 mm	A: Ø 4.7 mm B: 4.5 mm C: 5.7 mm	A: Ø 4.7 mm B: 5.5 mm C: 6.7 mm
Code	TCT-N 0.75 CHC	TCT-N 1.5 CHC	TCT-N 2.5 CHC	TCT-N 3.5 CHC	TCT-N 4.5 CHC	TCT-N 5.5 CHC
Ref. No.	5242	5243	5244	5245	5246	5247

20
NCM

	MULTI-UNIT ANGLED ABUTMENTS CHC					
Angle	17°			30°		
Dimensions	A: Ø 4.7 B: 1.5 mm	A: Ø 4.7 B: 2.5 mm	A: Ø 4.7 B: 3.5 mm	A: Ø 4.7 B: 1.5 mm	A: Ø 4.7 B: 2.5 mm	A: Ø 4.7 B: 3.5 mm
Code	AU 17-1.5 CHC	AU 17-2.5 CHC	AU 17-3.5 CHC	AU 30-1.5 CHC	AU 30-2.5 CHC	AU 30-3.5 CHC
Ref. No.	7482	7483	7484	7487	7488	7489



DUAL USE SCAN BODIES FOR MULTI-UNITS			ADHESIVE COPINGS FOR MULTI-UNITS	
			ENGAGED	NON-ENGAGED
				
Height	7 mm	7 mm	3.5 mm	3.5 mm
Code	IOSB-TCT-N-R	IOSB-TCT-N	TAC-TCT-N 	TAC-TCT-N-R 
Ref. No.	3883	5003	5028	5029
Instructions	For bridge/bar restorations with multi-unit straight and angled abutments	For single crown restorations with multi-unit angled abutments.	For single tooth restorations	For bar/bridge restorations
	Screw included			

	SCREWS			ANALOG
				
Code	SF-N	SFT-N	S-DM-SR	AN-PM-CHC
Ref. No.	6092	6093	4994	4996
Instructions	Fixation screw for Multi-Unit restoration	Black coated screw for Lab	Direct mounting on metal frame. Should not be used for full zirconia or ceramic restorations	For resin printed models





DUAL USE SCAN BODY

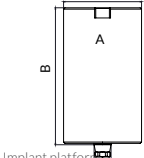

HEIGHT	10 mm
CODE	SB-CHC
REF. NO.	5021
INSTRUCTION	Screw included. Use 1.25 mm driver for insertion (see page 27)

Manual Tightening

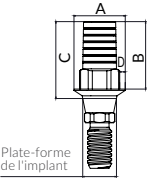

PRE-MILLED BLANK	
	
Dimensions	A: Ø11.5 mm B: 20.2 mm
Code	BA-PF-CHC
Ref. No.	4990
For Preface® abutment holder. Screw included. Use 1.25 mm driver for insertion (see page 27)	

20 NCM

TI-BASES				
	ENGAGED		NON-ENGAGED	
Height Gingivale	0.7 mm	2.5 mm	0.7 mm	2.5 mm
Dimensions	A: Ø3.8 mm B: 5 mm C: 5.7 mm D: 0.4 mm	A: Ø3.8 mm B: 4 mm C: 6.5 mm D: 0.42 mm	A: Ø3.6 mm B: 5 mm C: 5.7 mm D: 0.5 mm	A: Ø3.8 mm B: 4 mm C: 6.5 mm D: 0.5 mm
Code	CCTB-CHC ◻	CCTB-CHC-2.5 ◻	CCTB-CHC-R ○	CCTB-CHC-R-2.5 ○
Ref. No.	5026	4953	5027	4954
Instructions	Screw included. Use 1.25 mm driver for insertion (see page 27)			

20 NCM

SIRONA COMPATIBLE

TI-BASE	SCAN POST
	
Code	CCTB-CHC-SI
Code	CCSP-CHC-SI
Ref. No.	4982
Ref. No.	4985
Instructions	For scanning and/or restoration use
Instructions	For scanning only
Screw included. Use 1.25 mm driver for insertion (see page 27)	

20 NCM



OVERDENTURE RESTORATIONS



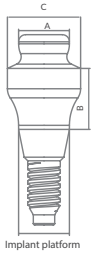





ALPHALOC ABUTMENT SYSTEM



ALPHALOC







	A: 2.5 mm B: 0.5 mm C: 2.5 mm	A: 2.5 mm B: 1.0 mm C: 3.6 mm	A: 2.5 mm B: 2.0 mm C: 3.6 mm	A: 2.5 mm B: 3.0 mm C: 3.6 mm	A: 2.5 mm B: 4.0 mm C: 3.6 mm	A: 2.5 mm B: 5.0 mm C: 3.6 mm
Dimensions 	7470	7471	7472	7473	7474	7475
Instructions	Kit includes: 1 attachment of the given height, 1 stainless steel metal housing, 4 retentive caps, 1 block-out spacer, 1 laboratory cap.					

	ALPHALOC PROCESSING PACKAGE	ALPHALOC RETENTIVE CAPS			
					
Ref. No.	4875	4876	4877	4878	4879
Includes	Stainless steel metal housing, block-out spacer, nylon retentive caps (violet, clear, pink and yellow), laboratory cap (black)	Violet (strong retention)	Clear (standard retention)	Pink (soft retention)	Yellow (extra soft retention)
		4 units per package			



OVERDENTURE RESTORATIONS

ALPHALOC ACCESSORIES

	LABORATORY CAP (BLACK)	BLOCK OUT SPACER	IMPRESSION COPING	MALE ANALOG	INSERTION TOOL*	EXTRACTION TOOL*
						
Includes	4 Units	1 Unit	4 Units	4 Units	1 Unit	1 Pièce
Ref. No.	4882	4883	4884	4885	4886*	4887*



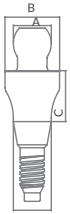

* In some markets, the insertion and extraction tool is provided as a single, dual sided instrument.

BALL ATTACHMENTS



STRAIGHT BALL ATTACHMENTS

**20
NCM**

					
Dimensions	A: 2.5 mm B: 2.5 mm C: 1.0 mm	A: 2.5 mm B: 3.6 mm C: 2.0 mm	A: 2.5 mm B: 3.6 mm C: 3.0 mm	A: 2.5 mm B: 3.6 mm C: 4.0 mm	A: 2.5 mm B: 3.6 mm C: 5.0 mm
Code	TB1-CHC	TB2-CHC	TB3-CHC	TB4-CHC	TB5-CHC
Ref. No.	7403	7404	7405	7406	7407
Instructions	Use 1.25 driver for insertion (see page 27). Use nylon cap Ø 2.5 mm.				

NYLON CAP FOR Ø 2.5 MM				
	Stainless steel Housing	Nylon Cap	Nylon Cap with Titanium Ring	Soft Nylon Cap
				
Code	H	NC	NCT	NCA
Ref. No.	6240	6250	6251	6253







Conical Standard Connection (CS)

The MultiNeO implant is based on over three decades of proven clinical studies & experience. The implant's conical connection, unique implant design features and the prosthetic line contribute to preserving the soft and hard tissues in immediate and delayed implant procedures.



3.75, Ø 4.2, Ø 5.0



CONNECTION	 CONICAL STANDARD
	Active implant designed for immediate implant procedures in a variety of bone types
RECOMMENDED BONE TYPE	   
DESIGN FEATURES	<ul style="list-style-type: none"> • Tapered • Centering and anchoring features • Double, variable threads • Micro-threads
CLINICAL BENEFITS	<ul style="list-style-type: none"> • High primary stability • Reduced marginal bone loss • Increased surface area • Increased BIC
ULTIMATE	



MULTINEO™

The MultiNeO implant System includes 3.75, 4.2 and 5.0 mm diameter implants with a Conical Standard (CS) connection. It is compatible with Alpha-Bio Tec's Conical Standard prosthetic line and CAD/CAM restoration parts.

Diameter	Length	Ref. No.	Dimensions				
			A	B	C	D	H
Ø 3.75	8 mm	1938	Ø 3.75	Ø 3.1	Ø 1.8	Ø 3.1	2.5
	10 mm	1930	Ø 3.75	Ø 2.9	Ø 1.5	Ø 3.1	2.5
	11.5 mm	1931	Ø 3.75	Ø 2.9	Ø 1.5	Ø 3.1	2.5
	13 mm	1933	Ø 3.75	Ø 2.9	Ø 1.5	Ø 3.1	2.5
	16 mm	1936	Ø 3.75	Ø 2.9	Ø 1.5	Ø 3.1	2.5
Ø 4.2	8 mm	1948	Ø 4.2	Ø 3.55	Ø 1.8	Ø 3.1	2.5
	10 mm	1940	Ø 4.2	Ø 3.3	Ø 1.8	Ø 3.1	2.5
	11.5 mm	1941	Ø 4.2	Ø 3.3	Ø 1.8	Ø 3.1	2.5
	13 mm	1943	Ø 4.2	Ø 3.3	Ø 1.8	Ø 3.1	2.5
	16 mm	1946	Ø 4.2	Ø 3.3	Ø 1.8	Ø 3.1	2.5
Ø 5.0	8 mm	1958	Ø 5.0	Ø 4.4	Ø 2.6	Ø 3.1	2.5
	10 mm	1950	Ø 5.0	Ø 4.1	Ø 2.3	Ø 3.1	2.5
	11.5 mm	1951	Ø 5.0	Ø 4.1	Ø 2.3	Ø 3.1	2.5
	13 mm	1953	Ø 5.0	Ø 4.1	Ø 2.3	Ø 3.1	2.5

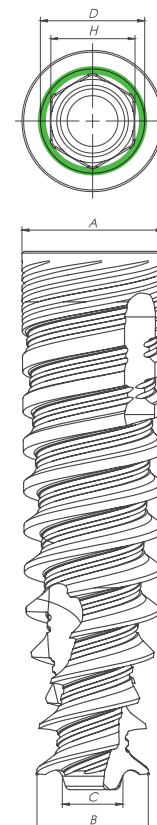

IMPLANT SYSTEM

IMPLANT PACKAGE

A modern and easy-to-use implant package with enhanced ergonomics.



DRIVERS

Color coded grip drivers with gingival height markings and lead pin for centering and easy insertion.

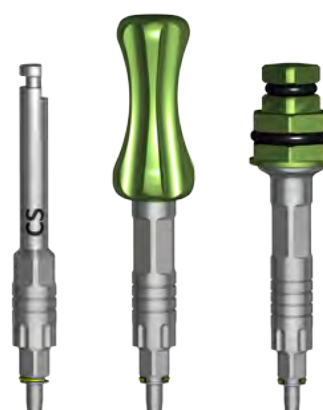

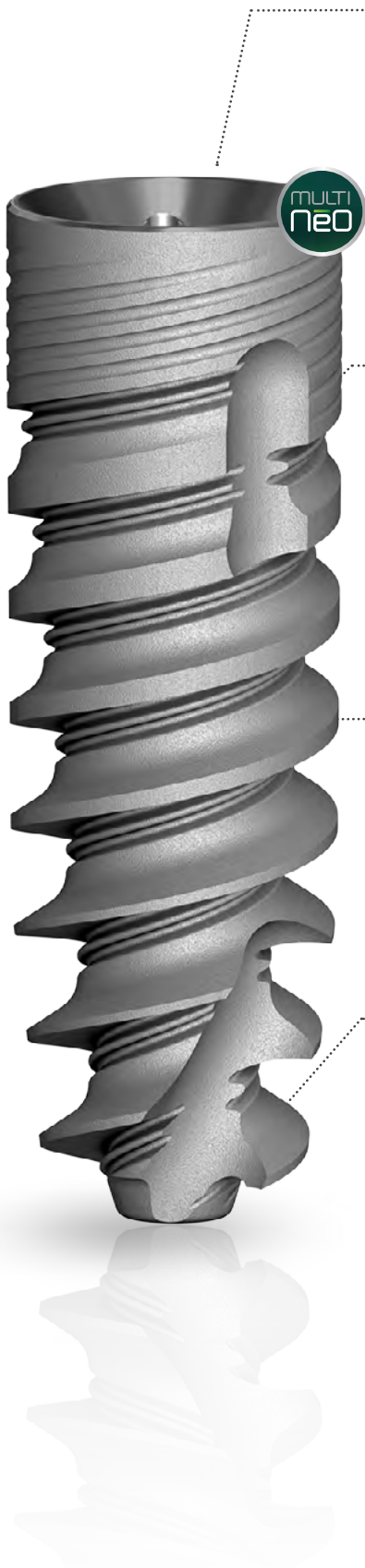

CORONAL PART

Design Features:

- Platform Switching
- Micro-threads
- Cutting flutes
- Internal hex and Conical standard

Clinical Benefits:

- Reduced pressure on cortical area
- Efficient cutting ability
- Improved bone preservation
- High initial stability

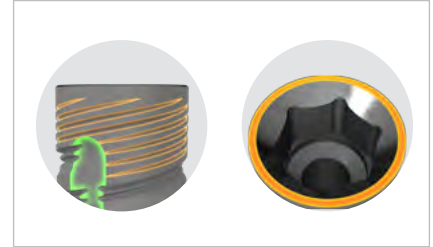

IMPLANT THREADS

Design Features:

- Variable thread design
- Double thread with 2.4mm step
- Micro-threads

Clinical Benefits:

- High cutting efficiency
- Osteotome like body
- Fast and controlled insertion
- Increased surface area
- Increased BIC

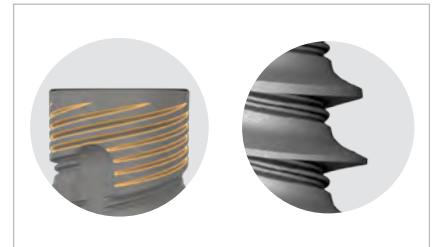

IMPLANT BODY AND CORE

Design Features:

- Straight coronal part
- Slightly tapered body
- Tapered core
- Tapered apical part

Clinical Benefits:

- Osteotome like body
- High primary stability

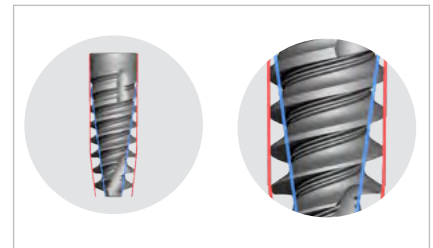

APICAL PART

Design Features:

- Narrow apex
- Sharp and deep threads
- Patented centering feature

Clinical Benefits:

- High primary stability
- Easy navigation and penetration
- Efficient cutting capability

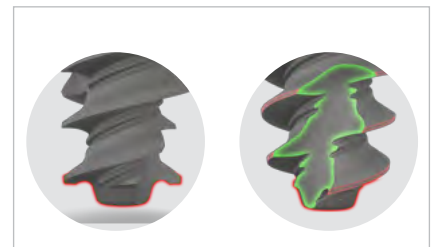

STEP DRILLING SEQUENCE

Ø 3.75

Bone Type IV		Bone Type II & III			Bone Type I			
Ø2.0	Ø2.4/Ø2.8	Ø2.0	Ø2.4/Ø2.8	Ø2.8/Ø3.2	Ø2.0	Ø2.4/Ø2.8	Ø2.8/Ø3.2	Ø3.2/Ø3.65 Cortical*

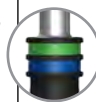

Ø 4.2

Bone Type IV			Bone Type II & III			Bone Type I			
Ø2.0	Ø2.4/Ø2.8	Ø2.8/Ø3.2	Ø2.0	Ø2.4/Ø2.8	Ø3.2/Ø3.65	Ø2.0	Ø2.4/Ø2.8	Ø3.2/Ø3.65	Ø3.65/Ø4.1 Cortical*

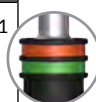

Ø 5.0

Bone Type IV			Bone Type II & III				Bone Type I					
Ø2.0	Ø2.4 / Ø2.8	Ø3.2 / Ø3.65	Ø2.0	Ø2.4 / Ø2.8	Ø3.2 / Ø3.65	Ø3.65 / Ø4.1	Ø2.0	Ø2.4 / Ø2.8	Ø3.2 / Ø3.65	Ø3.65 / Ø4.1	Ø4.1 / Ø4.5	Ø4.5 / Ø4.8 Cortical*

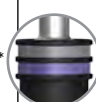

* Cortical - Drill through cortical plate with the larger diameter.

STRAIGHT DRILLING SEQUENCE

Ø 3.75

Bone Type IV			Bone Type II & III			Bone Type I			
Ø2.0	Ø2.4	Ø2.8**	Ø2.0	Ø2.8	Ø3.2**	Ø2.0	Ø2.8	Ø3.2**	Ø3.65 Cortical*



Ø 4.2

Bone Type IV			Bone Type II & III				Bone Type I				
Ø2.0	Ø2.8	Ø3.2**	Ø2.0	Ø2.8	Ø3.2	Ø3.65**	Ø2.0	Ø2.8	Ø3.2	Ø3.65**	Ø4.1 Cortical*



Ø 5.0

Bone Type IV				Bone Type II & III					Bone Type I						
Ø2.0	Ø2.8	Ø3.2	Ø3.65**	Ø2.0	Ø2.8	Ø3.2	Ø3.65	Ø4.1**	Ø2.0	Ø2.8	Ø3.2	Ø3.65	Ø4.1	Ø4.5**	Ø4.8 Cortical*



* Cortical - Drill through cortical plate

** 3mm shorter than implant's length. Note that drill can be replaced by a corresponding step drill throughout entire implant's length. For more information, see step protocol.

Important: Professional considerations may be required for adaptations of the drill protocol in specific cases.

MULTINEO™

ONE IMPLANT **MULTIPLE OPTIONS**

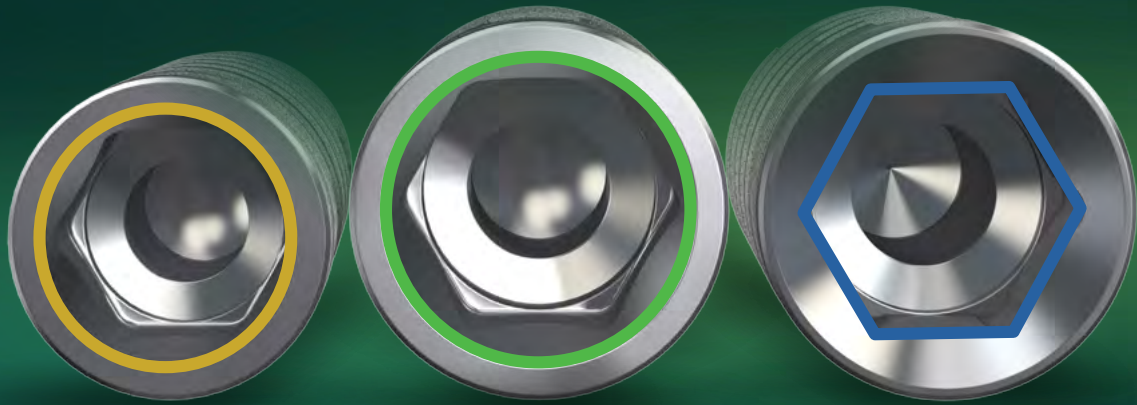

The Complete MULTINEO™ Implant Family

With more options to choose from, the MultiNeO™ family now includes 3 connections:



**Conical Narrow
Connection (CHC)**



**Conical Standard
Connection (CS)**



**Internal Hex
Connection (IH)**

Each connection features a dedicated restoration line

HEALING ABUTMENTS

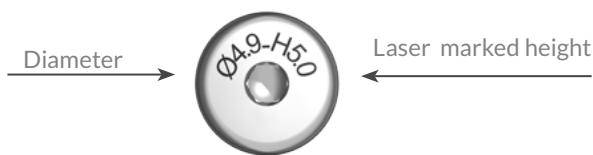

The healing abutment should protrude from the soft tissue margin, as shown.

If broadening of the soft tissue is required, it is possible to use a slim healing abutment (Ø 4.0 mm) first, and then switch to a standard or wide healing abutment (Ø 4.9 or Ø 6.2 mm), according to the clinical requirements.

Choosing the correct healing abutment

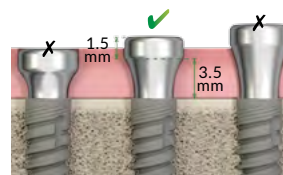

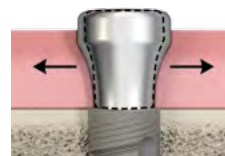

* Use 1.25 mm driver.

Broadening of the soft tissue

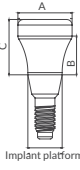

TITANIUM HEALING ABUTMENTS

Ø 4.0 MM						MANUAL TIGHTENING		
								
Dimensions	A: Ø 4.0 mm B: 1.5 mm C: 3 mm	A: Ø 4.0 mm B: 2.5 mm C: 4 mm	A: Ø 4.0 mm B: 3.5 mm C: 5 mm	A: Ø 4.0 mm B: 4.5 mm C: 6 mm	A: Ø 4.0 mm B: 5.5 mm C: 7 mm	HHS1.25 4052	HHSS1.25 4053	
Code	HA-D4-CH1.5-CS	HA-D4-CH2.5-CS	HA-D4-CH3.5-CS	HA-D4-CH4.5-CS	HA-D4-CH5.5-CS			
Ref. No.	3401	3402	3403	3404	3405			
Instructions	Use 1.25 mm driver for insertion (see page 27).							

Ø 4.9 MM					
					
Dimensions	A: Ø 4.9 mm B: 1.5 mm C: 3 mm	A: Ø 4.9 mm B: 2.5 mm C: 4 mm	A: Ø 4.9 mm B: 3.5 mm C: 5 mm	A: Ø 4.9 mm B: 4.5 mm C: 6 mm	A: Ø 4.9 mm B: 5.5 mm C: 7 mm
Code	HA-D4.9-CH1.5-CS	HA-D4.9-CH2.5-CS	HA-D4.9-CH3.5-CS	HA-D4.9-CH4.5-CS	HA-D4.9-CH5.5-CS
Ref. No.	3407	3408	3409	3410	3411

HEALING ABUTMENTS & IMPRESSION

Ø 6.2 MM		
		
		
Dimensions	A: Ø 6.2 mm B: 1.5 mm C: 3 mm	A: Ø 6.2 mm B: 2.5 mm C: 4 mm
Code	HA-D6.2-CH1.5-CS	HA-D6.2-CH2.5-CS
Ref. No.	3412	3413
Instructions	Use 1.25 mm driver for insertion (see page 27)	

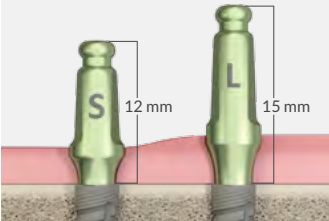



Transfer selection

It is recommended to use the short or long closed/open tray transfers with the utmost fit to the gingival design and the adjacent structures.

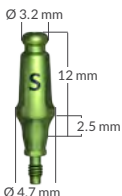
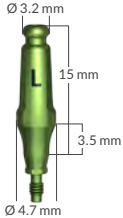
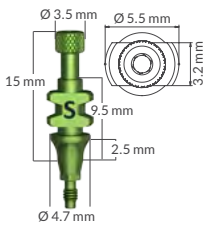
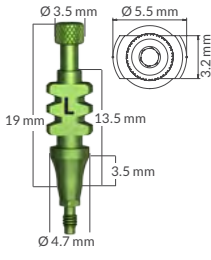





IMPRESSION TRANSFERS



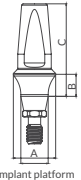



	SHORT CLOSED TRAY TRANSFER	LONG CLOSED TRAY TRANSFER	SHORT OPEN TRAY TRANSFER	LONG OPEN TRAY TRANSFER
				
Code	SCTT-CS	LCTT-CS	SOTT-CS	LOTT-CS
Ref. No.	3450	3451	3455	3456
Instructions	Use 1.25 mm driver for insertion (see page 27).			

30 NCM

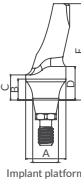

IMPLANT ANALOGS		
		
Code	BTT-N	IA-CS
Ref. No.	5211	3459
Instructions	For Multi-Unit restorations	For plaster model

ESTHETIC TITANIUM ABUTMENTS

STRAIGHT ABUTMENTS WITH VARIOUS CUFF HEIGHTS					30 NCM
					
Dimensions	A: Ø 4.8 mm B: 1.5 mm C: 9.5 mm	A: Ø 4.8 mm B: 2.5 mm C: 10.5 mm	A: Ø 4.8 mm B: 3.5 mm C: 11.5 mm	A: Ø 4.8 mm B: 4.5 mm C: 12.5 mm	To be used only on straight titanium abutments
Code	TLA-H1.5-CS	TLA-H2.5-CS	TLA-H3.5-CS	TLA-H4.5-CS	HTLASP
Ref. No.	3501	3502	3503	3504	5364
Instructions	Use 1.25 mm driver for insertion (see page 27).				

ANGLED ABUTMENTS 15°		ANGLED ABUTMENTS 25°		30 NCM	
					
Dimensions	A: Ø 4.8 mm B: 1.5 mm C: 2 mm D: 3 mm E: 10.5 mm	A: Ø 4.8 mm B: 2.5 mm C: 3 mm D: 4 mm E: 11.5 mm	Dimensions	A: Ø 4.8 mm B: 1.5 mm C: 2 mm D: 3 mm E: 10.5 mm	A: Ø 4.8 mm B: 2.5 mm C: 2 mm D: 3 mm E: 11.5 mm
Code	TLA-15-H1.5-CS	TLA-15-H2.5-CS	Code	TLA-25-H1.5-CS	TLA-25-H2.5-CS
Ref. No.	3511	3512	Ref. No.	3514	3515
Instructions	Use 1.25 mm driver for insertion (see page 27).				

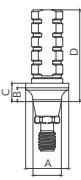
TEMPORARY ABUTMENTS

TEMPORARY ABUTMENTS		
		
Dimensions	A: Ø 4.7 mm B: 1.5 mm C: 2 mm D: 10 mm	A: Ø 4.7 mm B: 1.5 mm C: 2 mm D: 10 mm
Code	TA-AR-CS	TA-R-CS
Ref. No.	3532	3533
Instructions	Use 1.25 mm driver for insertion (see page 27).	

CASTING ABUTMENTS

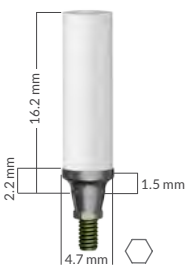
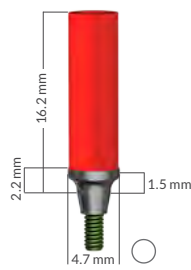
SCREW	CoCr BASE ABUTMENTS*		30 NCM
			
Code	CCS-CS	CoCr-AR-CHCS	CoCr-R-CHCS
Ref. No.	3462	3846	3847
Instructions	Melting Range: 1200°C - 1330°C Recommended sintering below 900°C		
Instructions	Use 1.25 mm driver for insertion (see page 27).		

* Note: remove screw and titanium base before sintering

SCREW RETAINED RESTORATIONS

ANGLED ABUTMENTS			IMPLANTS	STRAIGHT ABUTMENTS		OPEN TRAY TRANSFER	CLOSED TRAY		
	3862 AU 17-1.5 CS	A: Ø 4.7 B: 1.5 mm	 Ø 3.75 Ø 4.2 Ø 5		3870 TCT-0.75-CS A: Ø 4.7 mm B: 0.5 mm C: 0.75 mm D: 1.9 mm				
	3863 AU 17-2.5 CS	A: Ø 4.7 B: 2.5 mm			3871 TCT-1.5-CS A: Ø 4.7 mm B: 1.5 mm C: 2 mm D: 3.2 mm				
	3684 AU 17-3.5 CS	A: Ø 4.7 B: 3.5 mm			3872 TCT-2.5-CS A: Ø 4.7 mm B: 2.5 mm C: 3 mm D: 4.2 mm	ANALOG			
	3867 AU 30-1.5 CS	A: Ø 4.7 B: 1.5 mm						5211 BTT-N	
	3868 AU 30-2.5 CS	A: Ø 4.7 B: 2.5 mm					FIXATION SCREW		
	3869 AU 30-3.5 CS	A: Ø 4.7 B: 3.5 mm							6092 SF-N 6093 SFT-N
						TEMPORARY ABUTMENT			
4055 1.25 mm				4057 1.5 mm			5216 TTA-N Includes screw 6092.		
1.25 MM DRIVER			1.5 MM DRIVER		PRO HEALING ABUTMENTS				
								5236 HCT4-N	
4052 HHS 1.25	4053 HHSS 1.25	4061 HTD 1.25 L	4055 HTD 1.25	4056 HTD 1.25 S	4165 HTD 1.25 M		5237 HCT6-N Integrated screw		
									
					BURNOUT SLEEVE				
							5217 PST-N-AR 5218 PST-N includes screw 6093.		

TORQUE

4572
TORQUE RATCHET



Straight Multi-Unit abutments CS	30 Ncm
Impression transfer and healing abutment	Manual Tightening
Temporary abutments	25 Ncm
Angled multi-unit abutment CS	30 Ncm

SCREW RETAINED RESTORATIONS



MULTI-UNIT ABUTMENTS

	ANGLE 17°			ANGLE 30°		
Dimensions	A: Ø 4.7 mm B: 1.5 mm	A: Ø 4.7 mm B: 2.5 mm	A: Ø 4.7 mm B: 3.5 mm	A: Ø 4.7 mm B: 1.5 mm	A: Ø 4.7 mm B: 2.5 mm	A: Ø 4.7 mm B: 3.5 mm
Code	AU-17-1.5-CS	AU-17-2.5-CS	AU-17-3.5-CS	AU-30-1.5-CS	AU-30-2.5-CS	AU-30-3.5-CS
Ref. No.	3862	3863	3864	3867	3868	3869
Instructions	Use 1.25 mm driver for insertion (see page 27).					

30
NCM

	MULTI-UNIT STRAIGHT ABUTMENTS		
Dimensions	A: Ø 4.7 mm B: 0.5 mm C: 0.75 mm D: 1.9 mm	A: Ø 4.7 mm B: 1.5 mm C: 2 mm D: 3.2 mm	A: Ø 4.7 mm B: 2.5 mm C: 3 mm D: 4.2 mm
Code	TCT-0.75-CS	TCT-1.5-CS	TCT-2.5-CS
Ref. No.	3870	3871	3872
Instructions	Use 1.5 mm driver for insertion (see page 27).		

30
NCM





HBC ABUTMENTS





	STRAIGHT ABUTMENTS - FOR SINGLE IMPLANT RESTORATION		
Dimensions	A: Ø 4.7 mm B: 0.5 mm C: 0.75 mm D: 2.8 mm	A: Ø 4.7 mm B: 1.5 mm C: 2 mm D: 4.1 mm	A: Ø 4.7 mm B: 2.5 mm C: 3 mm D: 5.1 mm
Code	HBC-H0.75-CS	HBC-H1.5-CS	HBC-H2.5-CS
Ref. No.	3876	3877	3878
Instructions	Use 1.25 mm driver for insertion (see page 27).		



30
NCM

Note: package includes HBC abutment screw and burnout sleeve.

CAD/CAM RESTORATION PARTS

DUAL USE SCAN BODIES FOR MULTI-UNITS		ADHESIVE COPINGS FOR MULTI-UNITS	
		10 NCM	
		ENGAGED	NON-ENGAGED
			
Height	7 mm	7 mm	3.5 mm
Code	IOSB-TCT-N-R	IOSB-TCT-N	TAC-TCT-N
Ref. No.	3883	5003	5028 
Instructions	For bridge/bar restorations with multi-unit straight and angled abutments	For single crown restorations with multi-unit angled abutments	For single tooth restorations
	Screw included		For bar/bridge restorations

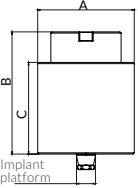



SCREWS					RETRIEVAL SCREW
					
Code	SF-N	SFT-N	S-DM-SR	STLA-CS	RS
Ref. No.	6092	6093	4994	3510	5110
Instructions	Fixation screw for Multi-Unit restoration	Black coated screw for Lab	Direct mounting on metal frame. Should not be used for full zirconia or ceramic restorations	Prosthetic replacement screw	Fits IH and CS platforms

PRE-MILLED BLANKS		ANALOG
		
Dimensions	A: Ø15.8 mm B: 20 mm C: 15 mm	A: Ø11.5 mm B: 20 mm
Code	WBA-PF-CS	BA-PF-CS
Ref. No.	3855	3854
Instructions	For Preface® abutment holder. Screw included	
Code		AN-PM-CS
Ref. No.		3838
Instructions		For resin printed model



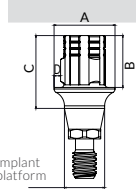



DUAL USE SCAN BODY

HEIGHT	10 mm	Manual Tightening
CODE	IOSB-CS	
REF. NO.	3837	
INSTRUCTION	Use 1.25 mm driver for insertion (see page 27)	

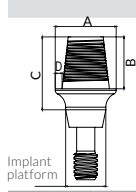
TI-BASES - ENGAGED			
			
	Gingival Height	0.75 mm	1.5 mm
Dimensions	A: Ø4.7 mm B: 4 mm C: 4.87 mm D: 0.5 mm	A: Ø4.7 mm B: 4 mm C: 5.62 mm D: 0.53 mm	A: Ø4.7 mm B: 4 mm C: 6.62 mm D: 0.5 mm
Code	TB-0.75-AR-CS	TB-1.5-AR-CS	TB-2.5-AR-CS
Ref. No.	3832	3840	3842
Instructions	Screw included.		

30 NCM

TI-BASES - NON ENGAGED			
			
	Gingival Height	0.75 mm	1.5 mm
Dimensions	A: Ø4.7 mm B: 4 mm C: 4.87 mm D: 0.53 mm	A: Ø4.7 mm B: 4 mm C: 5.62 mm D: 0.53 mm	A: Ø4.7 mm B: 4 mm C: 6.62 mm D: 0.53 mm
Code	TB-0.75-R-CS	TB-1.5-R-CS	TB-2.5-R-CS
Ref. No.	3833	3841	3843
Instructions	Screw included.		

30 NCM





SIRONA COMPATIBLE





	TI-BASE	SCAN POST
Code	CSTB-CS-SI	CSSP-CS-SI
Ref. No.	3856	3857
Instructions	For scanning and/or restoration use	For scanning only

30 NCM







OVERDENTURE RESTORATIONS

ALPHALOC ABUTMENT SYSTEM

ALPHALOC					
	30 NCM				
					
Dimensions	A: Ø 3.1 mm B: 0.75 mm C: 2.4 mm	A: Ø 3.9 mm B: 2 mm C: 3.7 mm	A: Ø 3.9 mm B: 3 mm C: 4.7 mm	A: Ø 3.9 mm B: 4 mm C: 5.7 mm	
Code	AK-0.75 - CS	AK-1.5 - CS	AK-2.5 - CS	AK-3.5 - CS	
Ref. No.	3710	3711	3712	3713	
Instructions	Kit includes: 1 AlphaLoc abutment of the given height, 1 stainless steel metal housing, 4 retentive caps, 1 block-out spacer, 1 laboratory cap. Use 1.25 mm driver for insertion (see page 27)				

	ALPHALOC PROCESSING PACKAGE	ALPHALOC RETENTIVE CAPS			
					
Ref. No.	4875	4876	4877	4878	4879
Includes	Stainless steel metal housing, block-out spacer, nylon retentive caps (violet, clear, pink and yellow), laboratory cap (black)	Violet (strong retention)	Clear (standard retention)	Pink (soft retention)	Yellow (extra soft retention)
	4 units per package				

ALPHALOC ACCESSORIES

	LABORATORY CAP (BLACK)	BLOCK OUT SPACER	IMPRESSION COPING	MALE ANALOG	INSERTION TOOL *	EXTRACTION TOOL *
						
Content	4 Units	1 Unit	4 Units	4 Units	1 Unit	1 Unit
Ref. No.	4882	4883	4884	4885	4886*	4887*

* In some markets, the insertion and extraction tool is provided as a single, dual sided instrument.

GUIDED SURGERY TOOL KIT (GSTK)

Use the software of your choice with the Alpha-Bio Tec. GSTK

The tray features a modular layout.

The contents are organized to support the entire guided surgery procedure from site preparation to final implantation.

All kit components fit the matching master sleeves.



1

**SITE
PREPARATION**

2

OSTEOTOMY

3

**IMPLANT
PLACEMENT**

4

**TOOLS &
ACCESSORIES**



Note: The ratchet is NOT included in the kit. Image is for illustration purposes only.

1

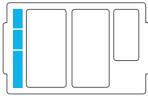

SITE PREPARATION

Contains tissue punches, drills, and pins required to prepare the osteotomy and anchor the surgical guide.

2



OSTEOTOMY

Contains the color-coded drills required for the drilling sequence to perform the guided osteotomy.

3



IMPLANT PLACEMENT

Contains implant mounts and their associated screws required to place the implant through the guide. The implant mounter is attached to the implant and enables increased accuracy and predictability of implant positioning during placement.

4



TOOLS & ACCESSORIES

Contains a variety of tools and accessories required to perform the surgical procedure without the need of supplementary external tools.



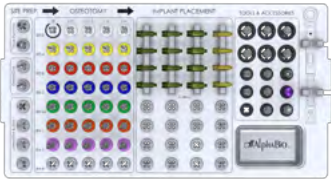
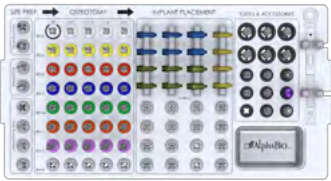

Use the software of your choice with the Alpha-Bio Tec. GSTK

THE KIT IS AVAILABLE IN 3 DIFFERENT CONFIGURATIONS:

	<p>Ref., KIT#65000</p>	<p>Full guided surgery kit for Internal Hex (IH) and Conical Narrow Connections (CHC)</p>
	<p>Ref., KIT#65002</p>	<p>Full guided surgery kit for Conical Standard (CS) and Conical Narrow Connections (CHC)</p>
	<p>Ref., KIT#65003</p>	<p>Full guided surgery kit for Internal Hex (IH), Conical Standard (CS) and Conical Narrow Connections (CHC)</p>

* Note: The ratchet is NOT included in the kit.

THE SLEEVES

	MASTER SLEEVE Used for guided drilling and implant insertion		SECURING SLEEVE Used to support lateral pin
			
CODE	SLS	SLL	SLSE
REF. NO.	66012	66013	66014
QTY.	5	5	5
INFO.	For Ø 3.2, Ø 3.3, Ø 3.5, Ø 3.7N, Ø 3.75 implants	For Ø 4.2, Ø 4.65, Ø 5.0, and Ø 5.3 implants	For 1.5 mm drill and lateral pin

NOTE: When using the Ø5.5 mm sleeve, an adaptor should be used in the initial drilling sequence to mitigate the tool size. If sleeve adaptors are used for the site preparation and osteotomy stages, they must be removed **before** inserting the implant through the guide (when applicable). Drills and implant mounts are prolonged by a fixed 9 mm to meet the extra height attained by the surgical guide, i.e. the tool's stopper is located **exactly 9 mm above** the implant level.

Master sleeves and securing sleeves are not supplied in the GSTK box. Sleeves are sold separately in units of 5 per/pkg.

1 SITE PREPARATION

	TISSUE PUNCH		CRESTAL DRILL		LATERAL PIN	Ø 1.5 MILLING DRILL
	<small>SMALL</small>	<small>LARGE</small>	<small>SMALL</small>	<small>LARGE</small>		
CODE	TPS	TPL	CDS	CDL	LP	MCD1.5
REF. NO.	65003	65004	65005	65006	65047	65050

2 OSTEOTOMY (For each diameter and length: Qty 1)

	Ø 2.0 SURGICAL DRILLS		Ø 2.4 SURGICAL DRILLS		Ø 2.8 SURGICAL DRILLS		Ø 3.2 SURGICAL DRILLS		Ø 3.65 SURGICAL DRILLS		Ø 4.1 SURGICAL DRILLS		Ø 4.5 SURGICAL DRILLS	
LENGTH	CODE	REF. NO.	CODE	REF. NO.	CODE	REF. NO.	CODE	REF. NO.	CODE	REF. NO.	CODE	REF. NO.	CODE	REF. NO.
8 MM	CD2-8	65007	CD2.4-8	65070	CD2.8-8	65012	CD3.2-8	65017	CD3.65-8	65022	CD4.1-8	65027	CD4.5-8	65032
10 MM	CD2-10	65008	CD2.4-10	65071	CD2.8-10	65013	CD3.2-10	65018	CD3.65-10	65023	CD4.1-10	65028	CD4.5-10	65033
11.5 MM	CD2-11.5	65009	CD2.4-11.5	65072	CD2.8-11.5	65014	CD3.2-11.5	65019	CD3.65-11.5	65024	CD4.1-11.5	65029	CD4.5-11.5	65034
13 MM	CD2-13	65010	CD2.4-13	65073	CD2.8-13	65015	CD3.2-13	65020	CD3.65-13	65025	CD4.1-13	65030	CD4.5-13	65035
16 MM	CD2-16	65011	CD2.4-16	65074	CD2.8-16	65016	CD3.2-16	65021	CD3.65-16	65026	CD4.1-16	65031	CD4.5-16	65036

3 IMPLANT PLACEMENT

	IMPLANT MOUNT IH		IMPLANT MOUNT CS		IMPLANT MOUNT SCREW IH/CS	IMPLANT MOUNT CHC	IMPLANT MOUNT CHC SCREW
	<small>SMALL</small>	<small>LARGE</small>	<small>SMALL</small>	<small>LARGE</small>			
CODE	IMS	IML	IMSC_CS	IMLC_CS	IMHS	IMC	IMCS
REF. NO.	65037	65038	65064	65065	65039	65055	65056

4 TOOLS & ACCESSORIES (Must be removed before implant insertion)

	SCREW-DRIVER	HEX DRIVER	IMPLANT MOUNT EXTENSION	HANDPIECE INSERTION ADAPTOR	IMPLANT MOUNT EXTRACTOR	UNIVERSAL SQUARE RATCHET HEAD ADAPTOR	L/S SLEEVE ADAPTOR DRIVER	SLEEVE ADAPTOR	CRESTAL PIN	IMPLANT MOUNT		IMPLANT MOUNT CHC DRIVER	
	<small>SHORT</small>		<small>ONE SIZE</small>			Enables use of 4 mm square driver heads		Used for adapting the small diameter drills to the large sleeve (SLL)	<small>SMALL</small>	<small>LARGE</small>	<small>SMALL</small>	<small>LARGE</small>	
CODE	HHSS1.25	HTD1.25S	IMX	HIA	IME	USH	SAD	SLSA*	CPS	CPL	IMSD	IMLD	IMCD
REF. NO.	4053	4056	65042	65044	65045	4012	65057	65058	65048	65049	65062	65063	65061

PRODUCTS
LIST
& REF. NO.

Ref. No.	CODE	PRODUCT DESCRIPTION	PAGE NO.
109	HS3	Healing Abutmen L3.0MM	45
110	HS5	Healing Abutmen L5.0MM	45
112	HSS3	Slim Healing Abutment L3.0mm	44
113	HSS5	Slim Healing Abutment L5.0mm	44
114	HSS4	Slim Healing Abutment L4.0mm	44
116	HS2	Healing Abutment L2.0mm	45
117	HS4	Healing Abutment L4.0mm	45
118	HS6	Healing Abutment L6.0mm	45
119	HS7	Healing Abutment L7.0mm	45
124	HS5-3	Healing Abutment D5.0 H3.0mm	45
125	HS5-5	Healing Abutment D5.0 H5.0mm	45
126	HS5.5-3	Healing Abutment D5.5 L3.0mm	45
127	HS5.5-5	Healing Abutment D5.5 H5.0mm	45
128	HS6-3	Healing Abutment D6.0 H3.0mm	45
129	HS6-5	Healing Abutment D6.0 H5.0mm	45
130	HS7-3	Healing Abutment D7.0 H3.0mm	45
1000	ICE	Implant Classical Esthetic Narrow D3.7mm L10mm	34
1001	ICE	Implant Classical Esthetic Narrow D3.7mm L11.5mm	34
1003	ICE	Implant Classical Esthetic Narrow D3.7mm L13mm	34
1010	ICE	Implant Classical Esthetic D3.75mm L10mm	34
1011	ICE	Implant Classical Esthetic D3.75mm L11.5mm	34
1013	ICE	Implant Classical Esthetic D3.75mm L13mm	34
1016	ICE	Implant Classical Esthetic D3.75mm L16mm	34
1018	ICE	Implant Classical Esthetic D3.75mm L8mm	34
1020	ICE	Implant Classical Esthetic D4.2mm L10mm	34
1021	ICE	Implant Classical Esthetic D4.2mm L11.5mm	34
1023	ICE	Implant Classical Esthetic D4.2mm L13mm	34
1026	ICE	Implant Classical Esthetic D4.2mm L16mm	34
1028	ICE	Implant Classical Esthetic D4.2mm L8mm	34
1030	ICE	Implant Classical Esthetic D4.65mm L10.0mm	34
1031	ICE	Implant Classical Esthetic D4.65mm L11.5mm	34
1033	ICE	Implant Classical Esthetic D4.65mm L13.0mm	34
1036	ICE	Implant Classical Esthetic D4.65mm L6.0mm	34
1038	ICE	Implant Classical Esthetic D4.65mm L8.0mm	34
1040	ICE	Implant Classical Esthetic D5.3mm L10mm	34
1041	ICE	Implant Classical Esthetic D5.3mm L11.5mm	34
1043	ICE	Implant Classical Esthetic D5.3mm L13mm	34
1046	ICE	Implant Classical Esthetic D5.3mm L6mm	34
1048	ICE	Implant Classical Esthetic D5.3mm L8mm	34
1056	ICE	Implant Classical Esthetic D4.2mm L6mm	34
1060	NICE	NICE D3.2mm L10mm	66
1061	NICE	NICE D3.2mm L11.5mm	66
1063	NICE	NICE D3.2mm L13mm	66
1066	NICE	NICE D3.2mm L16mm	66
1068	NICE	NICE D3.2mm L8mm	66

Ref. No.	CODE	PRODUCT DESCRIPTION	PAGE NO.
1260	DFI	Dual Fit Implant D3.75mm L10.0mm	42
1261	DFI	Dual Fit Implant D3.75mm L11.5mm	42
1263	DFI	Dual Fit Implant D3.75mm L13.0mm	42
1266	DFI	Dual Fit Implant D3.75mm L16.0mm	42
1268	DFI	Dual Fit Implant D3.75mm L8.0mm	42
1270	DFI	Dual Fit Implant D4.2mm L10.0mm	42
1271	DFI	Dual Fit Implant D4.2mm L11.5mm	42
1273	DFI	Dual Fit Implant D4.2mm L13.0mm	42
1276	DFI	Dual Fit Implant D4.2mm L16.0mm	42
1278	DFI	Dual Fit Implant D4.2mm L8.0mm	42
1280	DFI	Dual Fit Implant D3.3mm L10.0mm	42
1281	DFI	Dual Fit Implant D3.3mm L11.5mm	42
1283	DFI	Dual Fit Implant D3.3mm L13.0mm	42
1286	DFI	Dual Fit Implant D3.3mm L16.0mm	42
1288	DFI	Dual Fit Implant D3.3mm L8.0mm	42
1290	DFI	Dual Fit Implant D5.0mm L10.0mm	42
1291	DFI	Dual Fit Implant D5.0mm L11.5mm	42
1293	DFI	Dual Fit Implant D5.0mm L13.0mm	42
1296	DFI	Dual Fit Implant D5.0mm L16.0mm	42
1298	DFI	Dual Fit Implant D5.0mm L8.0mm	42
1300	Spiral	Spiral Implant D3.3mm L10.0mm	38
1301	Spiral	Spiral Implant D3.3mm L11.5mm	38
1303	Spiral	Spiral Implant D3.3mm L13.0mm	38
1306	Spiral	Spiral Implant D3.3mm L16.0mm	38
1308	Spiral	Spiral Implant D3.3mm L8.0mm	38
1330	Spiral	Spiral Implant D4.2mm L10.0mm	38
1331	Spiral	Spiral Implant D4.2mm L11.5mm	38
1333	Spiral	Spiral Implant D4.2mm L13.0mm	38
1336	Spiral	Spiral Implant D4.2mm L16.0mm	38
1338	Spiral	Spiral Implant D4.2mm L8.0mm	38
1340	Spiral	Spiral Implant D5.0mm L10.0mm	38
1341	Spiral	Spiral Implant D5.0mm L11.5mm	38
1343	Spiral	Spiral Implant D5.0mm L13.0mm	38
1346	Spiral	Spiral Implant D5.0mm L16.0mm	38
1348	Spiral	Spiral Implant D5.0mm L8.0mm	38
1350	Spiral	Spiral Implant D3.75mm L10.0mm	38
1351	Spiral	Spiral Implant D3.75mm L11.5mm	38
1353	Spiral	Spiral Implant D3.75mm L13.0mm	38
1356	Spiral	Spiral Implant D3.75mm L16.0mm	38
1358	Spiral	Spiral Implant D3.75mm L8.0mm	38
1360	Spiral	Spiral Implant D6.0mm L10.0mm	38
1361	Spiral	Spiral Implant D6.0mm L11.5mm	38
1363	Spiral	Spiral Implant D6.0mm L13.0mm	38
1368	Spiral	Spiral Implant D6.0mm L8.0mm	38
1900	MULTINEO	MULTINEO C D3.2mm L10.0mm	62

Ref. No.	CODE	PRODUCT DESCRIPTION	PAGE NO.
1901	MULTINEO	MULTINEO C D3.2mm L11.5mm	62
1903	MULTINEO	MULTINEO C D3.2mm L13.0mm	62
1906	MULTINEO	MULTINEO C D3.2mm L16.0mm	62
1908	MULTINEO	MULTINEO C D3.2mm L8.0mm	62
1920	MULTINEO	MULTINEO C D3.5mm L10.0mm	62
1921	MULTINEO	MULTINEO C D3.5mm L11.5mm	62
1923	MULTINEO	MULTINEO C D3.5mm L13.0mm	62
1926	MULTINEO	MULTINEO C D3.5mm L16.0mm	62
1928	MULTINEO	MULTINEO C D3.5mm L8.0mm	62
1930	MULTINEO	MULTINEO CS D3.75mm L10.0mm	82
1931	MULTINEO	MULTINEO CS D3.75mm L11.5mm	82
1933	MULTINEO	MULTINEO CS D3.75mm L13.0mm	82
1936	MULTINEO	MULTINEO CS D3.75mm L16.0mm	82
1938	MULTINEO	MULTINEO CS D3.75mm L8.0mm	82
1940	MULTINEO	MULTINEO CS D4.2mm L10.0mm	82
1941	MULTINEO	MULTINEO CS D4.2mm L11.5mm	82
1943	MULTINEO	MULTINEO CS D4.2mm L13.0mm	82
1946	MULTINEO	MULTINEO CS D4.2mm L16.0mm	82
1948	MULTINEO	MULTINEO CS D4.2mm L8.0mm	82
1950	MULTINEO	MULTINEO CS D5.0mm L10.0mm	82
1951	MULTINEO	MULTINEO CS D5.0mm L11.5mm	82
1953	MULTINEO	MULTINEO CS D5.0mm L13.0mm	82
1958	MULTINEO	MULTINEO CS D5.0mm L8.0mm	82
1960	MULTINEO	MULTINEO H D3.75mm L10.0mm	30
1961	MULTINEO	MULTINEO H D3.75mm L11.5mm	30
1963	MULTINEO	MULTINEO H D3.75mm L13.0mm	30
1966	MULTINEO	MULTINEO H D3.75mm L16.0mm	30
1968	MULTINEO	MULTINEO H D3.75mm L8.0mm	30
1970	MULTINEO	MULTINEO H D4.2mm L10.0mm	30
1971	MULTINEO	MULTINEO H D4.2mm L11.5mm	30
1973	MULTINEO	MULTINEO H D4.2mm L13.0mm	30
1976	MULTINEO	MULTINEO H D4.2mm L16.0mm	30
1978	MULTINEO	MULTINEO H D4.2mm L8.0mm	30
1980	MULTINEO	MULTINEO H D5.0mm L10.0mm	30
1981	MULTINEO	MULTINEO H D5.0mm L11.5mm	30
1983	MULTINEO	MULTINEO H D5.0mm L13.0mm	30
1988	MULTINEO	MULTINEO H D5.0mm L8.0mm	30
3401	HA-D-4-CH-1.5-CS	Healing Abutment D4 L1.5 CS	86
3402	HA-D-4-CH-2.5-CS	Healing Abutment D4 L2.5 CS	86
3403	HA-D-4-CH-3.5-CS	Healing Abutment D4 L3.5 CS	86
3404	HA-D-4-CH-4.5-CS	Healing Abutment D4 L4.5 CS	86
3405	HA-D-4-CH-5.5-CS	Healing Abutment D4 L5.5 CS	86
3407	HA-D-4.9-CH-1.5-CS	Healing Abutment D4.9 L1.5 CS	86
3408	HA-D-4.9-CH-2.5-CS	Healing Abutment D4.9 L2.5 CS	86
3409	HA-D-4.9-CH-3.5-CS	Healing Abutment D4.9 L3.5 CS	86

Ref. No.	CODE	PRODUCT DESCRIPTION	N° DE PAGE
3410	HA-D-4.9-CH-4.5-CS	Healing Abutment D4.9 L4.5 CS	86
3411	HA-D-4-CH-5.5-CS	Healing Abutment D4.9 L5.5 CS	86
3412	HA-D-6.2-CH-1.5-CS	Healing Abutment D6.2 L1.5 CS	87
3413	HA-D-6.2-CH-2.5-CS	Healing Abutment D6.2 L2.5 CS	87
3450	SCTT-CS	Short Closed Tray Transfer	87
3451	LCTT-CS	Long Closed Tray Transfer	87
3455	SOTT-CS	Short Open Tray Transfer	87
3456	LOTT-CS	Long Open Tray Transfer	87
3459	IA-CS	Implants Analog CS	87
3462	CCS-CS	CrCo Casting Screw CS	88
3501	TLA-H-1.5-CS	Straight Titanium Abutments H1.5mm CS	88
3502	TLA-H-2.5-CS	Straight Titanium Abutments H2.5mm CS	88
3503	TLA-H-3.5-CS	Straight Titanium Abutments H3.5mm CS	88
3504	TLA-H-4.5-CS	Straight Titanium Abutments H4.5mm CS	88
3511	TLA-15-H-1.5-CS	Angled Abutment 15° CH1.5 CS	88
3512	TLA-15-H-2.5-CS	Angled Abutment 15° CH2.5 CS	88
3514	TLA-25-H-1.5-CS	Angled Abutment 25° CH1.5 CS	88
3515	TLA-25-H-2.5-CS	Angled Abutment 25° CH2.5 CS	88
3532	TA-AR-CS	Temporary Titanium Abutments AR	88
3533	TA-R-CS	Temporary Titanium Abutments R	88
3613	TLABCC-CHC	Chrome Cobalt Casting Abutment - CHC	72
3614	TLABCC-R-CHC	Chrome Cobalt Casting Abutment Rotational - CHC	72
3616	CCS-CHC	CrCo Casting screw -CHC	72
3710	AA-0.75-CS	AlphaLoC Kit H 0.75 mm CS	93
3711	AA-1.5-CS	AlphaLoC Kit H 1.5 mm CS	93
3712	AA-2.5-CS	AlphaLoC Kit H 2.5 mm CS	93
3713	AA-3.5-CS	AlphaLoC Kit H 3.5 mm CS	93
3801	ITD2.5 S CS	Implant Grip Driver Short	24
3803	ITD-2.5 L-CS	Implant Grip Driver Long	24
3804	IT-2.5-SM-CS	Motor Mount Driver Short 2.5mm CS	24
3805	IT-2.5-LM-CS	Motor Mount Driver Long 2.5mm CS	24
3806	MITD-2.5-CS	Manual Implant Driver 2.5mm CS	24
3832	TB-0.75-AR-CS	CAD/CAM Straight Ti-Base for restoration on CS implants	92
3833	TB-0.75-R-CS	CAD/CAM Straight Ti-Base for restoration on CS implants	92
3837	IOSB-CS	CAD/CAM Dual-use Scan Body for restoration on CS implants	92
3838	AN-PM-CS	Analog for printed model CS	91
3840	TB-1.5-AR-CS	CAD/CAM Straight Ti-Base for restoration on CS implants	92
3841	TB-1.5-R-CS	CAD/CAM Straight Ti-Base for restoration on CS implants	92
3842	TB-2.5-AR-CS	CAD/CAM Straight Ti-Base for restoration on CS implants	92
3843	TB-2.5-R-CS	CAD/CAM Straight Ti-Base for restoration on CS implants	92
3846	CoCr-AR-CHCS	CoCr Casting Abutment AR CS	88
3847	CoCr-R-CHCS	CoCr Casting Abutment R CS	88
3854	BA-PF-CS	CAD/CAM Pre-milled Blank D11.5mm for restoration on CS implants	91
3855	WBA-PF-CS	CAD/CAM Pre-milled Blank D15.8mm for restoration on CS implants	91
3856	CSTB-CS-SI	CAD/CAM SIRONA Straight Ti-Base for restoration on CS implants	92

Ref. No.	CODE	PRODUCT DESCRIPTION	PAGE NO.
3857	CSSP-CS-SI	CAD/CAM SIRONA Scan Post for restoration on CS implants	92
3862	AU 17-1.5-CS	Multi Unit Angled abutment 17° 1.5mm for restoration on CS implants	89, 90
3863	AU 17-2.5-CS	Multi Unit Angled abutment 17° 2.5mm for restoration on CS implants	89, 90
3864	AU 17-3.5-CS	Multi Unit Angled abutment 17° 3.5mm for restoration on CS implants	89, 90
3867	AU 30-1.5-CS	Multi Unit Angled abutment 30° 1.5mm for restoration on CS implants	89, 90
3868	AU 30-2.5-CS	Multi Unit Angled abutment 30° 2.5mm for restoration on CS implants	89, 90
3869	AU 30-3.5-CS	Multi Unit Angled abutment 30° 3.5mm for restoration on CS implants	89, 90
3870	TCT 0.75-CS	TCT-N L0.5mm abutment for restoration for up to 30° On CS Implants	89, 90
3871	TCT-1.5-CS	TCT-N L1.5mm abutment for restoration for up to 30° On CS Implants	89, 90
3872	TCT-2.5-CS	TCT-N L2.5mm abutment for restoration for up to 30° On CS Implants	89, 90
3876	HBC-H0.75-CS	HBC L0.5mm for Single Implant Restoration on CS Implants	90
3877	HBC-H1.5-CS	HBC L1.5mm for Single Implant Restoration on CS Implants	90
3878	HBC-H2.5-CS	HBC L2.5mm for Single Implant Restoration on CS Implants	90
3883	IOSB-TCT-N-R	Dual Use Scan Body for bridge restoration for multi unit	56,76,91
4052	HHS1.25	Hand Hex Screw Driver 1.25mm	27,54, 68,74,89
4053	HHSS1.25	Short Hand Hex Screw Driver 1.25mm	27,54, 68,74,89
4055	HTD 1.25	Hex Driver 1.25mm	27,54, 68,74,89
4056	HTD 1.25 S	Short Hex Driver 1.25mm	27,54, 74,89,97
4057	HTD1.5	Short Hex Driver 1.5mm	27,54, 74,89,97
4058	HTD1.5S	Pro Short Hex Driver 1.5mm	27,54, 74,89,97
4059	HHS1.5	Pro Hand Hex Screw Driver 1.5mm	27,54, 74,89,97
4060	HHL1.5	Pro Hand Hex Long Screw Driver 1.5mm	27,54, 774,89,97
4061	HTD 1.25L	Long Hex Driver 1.25mm	27,54, 74,89,97
4071	ITS 2.5/1.25	Short Motor Mount Hex Driver 2.5/1.25mm	25
4080	PDG	Parallel Depth Guide	26
4081	PDGS	Short Parallel Depth Guide	26
4082	PG	Drilling Parallel Guide	26
4100	IDG	Implant Depth Probe	26
4140	G-ITDL2.5	Implant Grip Driver Long 2.5mm	25
4141	G-ITDM2.5	Implant Grip Driver Standard 2.5mm	25
4142	G-ITDS2.5	Implant Grip Driver Short 2.5mm	25
4143	GITL2.5/1.25	Motor Mount Grip Driver Long 2.5/1.25mm	25
4145	GITS2.5/1.25	Motor Mount Grip Driver Short 2.5/1.25mm	25
4146	MITD2.5-IH	Implant Hand Driver 2.5mm IH	25
4147	MITD2.1 CHC	Implant Hand Driver 2.1mm CHC	24
4152	ITD 2.5 S	Hex Driver 2.5mm	25
4153	ITD 2.5 SS	Short Hex Driver 2.5mm	25
4161	IT 2.5M+	Motor Mount Hex Driver 2.5/1.25mm	25
4165	HT 1.25M	Motor Mount Hex Driver 1.25mm	27
4168	HT1.5	Motor Mount Hex Driver 1.5mm	27
4220	SDH	Surgical Screwdriver	26
4240	DX	Drill Extension L17.5mm	21
4304	RB3	Round Burr D3.0mm	21
4550	BD2.0	Alpha Straight Drill_D2.0	22
4551	BD2.4	Alpha Straight Drill_D2.4	22

Ref. No.	CODE	PRODUCT DESCRIPTION	PAGE NO.
4552	BD2.8	Alpha Straight Drill_D2.8	22
4553	BD3.0	Alpha Straight Drill_D3.0	22
4554	BD3.2	Alpha Straight Drill_D3.2	22
4555	BD3.65	Alpha Straight Drill_D3.65	22
4556	BD4.1	Alpha Straight Drill_D4.1	22
4557	BD4.5	Alpha Straight Drill_D4.5	22
4558	BD4.8	Alpha Straight Drill_D4.8	22
4559	BD5.2	Alpha Straight Drill_D5.2	22
4560	BD5.8	Alpha Straight Drill_D5.8	22
4561	DS-A-L6	Alpha Drill Stopper A-D2.0-2.4 L6	20
4562	DS-A-L8	Alpha Drill Stopper A-D2.0-2.4 L8	20
4563	DS-A-L10	Alpha Drill Stopper A-D2.0-2.4 L10	20
4564	DS-A-L11.5	Alpha Drill Stopper A-D2.0-2.4 L11.5	20
4565	DS-A-L13	Alpha Drill Stopper A-D2.0-2.4 L13	20
4566	DS-B-L6	Alpha Drill Stopper B-D2.8-3.0 L6	20
4567	DS-B-L8	Alpha Drill Stopper B-D2.8-3.0 L8	20
4568	DS-B-L10	Alpha Drill Stopper B-D2.8-3.0 L10	20
4569	DS-B-L11.5	Alpha Drill Stopper B-D2.8-3.0 L11.5	20
4570	DS-B-L13	Alpha Drill Stopper B-D2.8-3.0 L13	20
4572	URT	Universal Torque Ratchet 10-45Ncm	26
4573	DS-C-L6	Alpha Drill Stopper C-D3.2-3.65 L6	20
4574	DS-C-L8	Alpha Drill Stopper C-D3.2-3.65 L8	20
4575	DS-C-L10	Alpha Drill Stopper C-D3.2-3.65 L10	20
4576	DS-C-L11.5	Alpha Drill Stopper C-D3.2-3.65 L11.5	20
4577	DS-C-L13	Alpha Drill Stopper C-D3.2-3.65 L13	20
4578	DS-D-L6	Alpha Drill Stopper D-D4.1-4.5 L6	20
4579	DS-D-L8	Alpha Drill Stopper D-D4.1-4.5 L8	20
4580	DS-D-L10	Alpha Drill Stopper D-D4.1-4.5 L10	20
4581	DS-D-L11.5	Alpha Drill Stopper D-D4.1-4.5 L11.5	20
4582	DS-D-L13	Alpha Drill Stopper D-D4.1-4.5 L13	20
4590	BSD2.0-2.4	Alpha Step Drill_2.0/2.4	22
4592	BSD2.4-2.8	Alpha Step Drill_2.4/2.8	22
4593	BSD2.8-3.0	Alpha Step Drill_2.8/3.0	22
4594	BSD2.8-3.2	Alpha Step Drill_2.8/3.2	22
4595	BSD3.2-3.65	Alpha Step Drill_3.2/3.65	22
4596	BSD3.65-4.1	Alpha Step Drill_3.65/4.1	22
4597	BSD4.1-4.5	Alpha Step Drill_4.1/4.5	22
4598	BSD4.5-4.8	Alpha Step Drill_4.5/4.8	22
4599	BSD4.8-5.2	Alpha Step Drill_4.8/5.2	22
4611	MKB	Mini Surgical Organizer Box	16
4612	SSK	Stopper kit (Provided with 20 stoppers)	20
4672	CS	Countersink Drill D2.7-5.9mm	21
4699	OBSA-CS	Surgical Kit	16
4712C	MDRX1.5	Marking Drill-Sphere shape 1.5/L16	21
4774	MINI KIT	Step drills mini kit	16

Ref. No.	CODE	PRODUCT DESCRIPTION	PAGE NO.
4775	MINI KIT	Step drills mini kit without dish	16
4867	AK0.5	AlphaLoC Kit 0.5mm	58
4868	AK1	AlphaLoC Kit 1mm	58
4869	AK2	AlphaLoC Kit 2mm	58
4870	AK3	AlphaLoC Kit 3mm	58
4871	AK4	AlphaLoC Kit 4mm	58
4872	AK5	AlphaLoC Kit 5mm	58
4875	AMPP	AlphaLoC Male Processing Package	58, 78, 93
4876	AMSTR	AlphaLoC Male-Strong violate units (X4)	58, 78, 93
4877	AMSTA	AlphaLoC Male-Standard white units (X4)	58, 78, 93
4878	AMSOF	AlphaLoC Male-Soft pink units (X4)	58, 78, 93
4879	AMESO	AlphaLoC Male-Extra Soft yellow (X4)	58, 78, 93
4882	AML	AlphaLoC Male-Laboratory black units(X4)	58, 79, 93
4883	ABOS	AlphaLoC Block Out Spacer	58, 79, 93
4884	AIC	AlphaLoC Impression Coping (X4)	58, 79, 93
4885	AFA	AlphaLoC Male Analog (X4)	58, 79, 93
4886	AIT	AlphaLoC Insertion Tool	58, 79, 93
4887	AET	AlphaLoC Extraction Tool	58, 79, 93
4940	DRT 4	Trephine Drill D4.0mm	21
4950	DRT 5	Trephine Drill D5.0mm	21
4951	CCTB-2.5	CAD/CAM TiBase for single tooth restoration on IH implants	57
4952	CCTB-R-2.5	CAD/CAM Titanium Base-R for bar\bridge restoration on IH implants	57
4953	CCTB-CHC-2.5	CAD/CAM TiBase for single tooth restoration on CHC implants	77
4954	CCTB-CHCR2.5	CAD/CAM TiBase for bar\bridge restoration on CHC implants	77
4980	CCTB-IH-SI	CAD/CAM Sirona Ti=Base for scan or restoration on IH Implants	57
4982	CCTB-CHC-SI	CAD/CAM Sirona Ti=Base for scan or restoration on CHC Implants	77
4984	CCSP-IH-SI	CAD/CAM Sirona Scan Post for restoration on IH Implants	57
4985	CCSP-CHC-SI	CAD/CAM Sirona Scan Post for restoration on CHC Implants	77
4988	BA-PF-IH	CAD/CAM Pre-milled blanks for restoration on IH implants	56
4989	WBA-PF-IH	CAD/CAM Pre-milled wide blanks for restoration on IH implants	56
4990	BA-PF-CHC	CAD/CAM Pre-milled blanks for restoration on CHC implants	77
4994	S-DM-SR	CAD/CAM screw for direct mounting for restoration on TCT-N	56, 76, 91
4995	AN-PM	CAD\CAM Analog for printed models for restoration on IH implants	53,56
4996	AN-PM-CHC	CAD\CAM Analog for printed models for restoration on CHC implants	76,69
5003	IOSB-TCT-N	Dual Use Scan Body for lab	56,76,91
5007	WCCTB	CAD/CAM TiBase Wide for restoration on IH implants	57
5008	WCCTB-R	CAD/CAM TiBase R Wide for restoration on IH implants	57
5019	SB-IH	CAD/CAM Dual-use Scan Body for restoration on IH implants	57
5021	SB-CHC	CAD/CAM Dual-use Scan Body for restoration on CHC implants	77
5024	CCTB	CAD/CAM Titanium Base for single tooth restoration on IH implants	57
5025	CCTB-R	CAD/CAM Titanium Base-R for bar\bridge restoration on IH implants	57
5026	CCTB-CHC	CAD/CAM Titanium Base- for single tooth restoration on CHC implants	77
5027	CCTB-CHC-R	CAD/CAM Titanium Base for bar\bridge restoration on CHC implants	77
5028	TAC-TCT-N	CAD/CAM Adhesive coping TCT-N for single tooth	56,76,91
5029	TAC-TCT-N-R	CAD/CAM Adhesive coping TCT-N for bar\bridge	56,76,91
5030	TLA	Straight Titanium Abutment	48

Ref. No.	CODE	PRODUCT DESCRIPTION	PAGE NO.
5031	ETLA	Esthetic Straight Titanium Abutment	52
5040	PLA	Straight Plastic Abutment Anti Rotation	53
5041	PLA-R	Straight Plastic Abutment Rotation	53
5060	HLT	Closed Tray Transfer	46
5061	HLTO	Open Tray Transfer	47
5062	HLTLS	Slim Closed Tray Transfer	47
5080	IA	Implant Analog	53
5090	TLA15	Angled Titanium Abutment 15°	49
5091	TLA15B	Angled Titanium Abutment 15° with Shoulder	49
5092	TLAL15	Long Angled Titanium Abutment 15°	49
5094	ETLAL15	Esthetic Long Angled Titanium Abutment 15°	52
5098	TLA15BB	Long Angled Titanium Abutment 15° with Shoulder	49
5110	RS	Retrieval Screw	53, 91
5121	STLAT	Torqfit Abutment Screw	53
5122	STLAS	Short Titanium Abutment Screw L8.3mm	53
5127	STLASH	Titanium Abutment Screw L7.6mm	53
5130	TLA25	Angled Titanium Abutment 25°	49
5131	ETLA25	Esthetic Angled Titanium Abutment 25°	52
5134	TLAL25	Titanium Lock Abutment 25° Long	49
5136	TLA35	Titanium Lock Abutment Angled 35°	49
5140	TLAL	Long Straight Titanium Abutment	48
5150	TLAS	Slim Straight Titanium Abutment	48
5155	ETLAS	Esthetic Slim Long Straight Titanium Abutment	52
5170	HLTS	Short Closed Tray Transfer	46
5171	HLTOS	Short Open Tray Transfer	47
5182	TLAO2	Omni Titanium Abutment Cuff H2.0mm	49
5200	TLAC-AR	Temporary Titanium Abutment Anti Rotation	51
5211	BTT-N	Pro Analog for TCT-N	53, 54, 69, 74, 87, 89
5216	TTA-N	Pro Temporary Titanium Abutment for TCT-N	54, 74, 89
5217	PST-N-AR	Pro Burnout Anti Rotation Sleeve for TCT-N	54, 74, 89
5218	PST-N	Pro Burnout Sleeve for TCT-N	54, 74, 89
5220	TLAC-R	Temporary Titanium Abutment Rotation	51
5221	TCT0.5-N	Pro Tapered Connection Abutment L 0.5mm	54, 55
5222	TCT1.5-N	Pro Tapered Connection Abutment L 1.5mm	54, 55
5223	TCT2.5-N	Pro Tapered Connection Abutment L 2.5mm	54, 55
5231	TST-N	Pro Open Tray Transfer for TCT-N/AUC-TCT-N	54, 74, 89
5235	TS-N	Pro Close Tray Transfer for TCT-N/TSA-N abutments	54, 74, 89
5236	HCT4-N	Pro Healing Abutment L4mm for TCT-N/AUC-TCT-N	54, 74, 89
5237	HCT6-N	Pro Healing Abutment L6mm for TCT-N/AUC-TCT-N	54, 74, 89
5242	TCT-N 0.75 CHC	Pro TCT-N L0.75mm abutments for restoration for up to 30°	74, 75
5243	TCT-N 1.5 CHC	Pro TCT-N L1.5mm abutments for restoration for up to 30°	74, 75
5244	TCT-N 2.5 CHC	Pro TCT-N L2.5mm abutments for restoration for up to 30°	74, 75
5245	TCT-N 3.5 CHC	Pro TCT-N L3.5mm abutments for restoration for up to 30°	74, 75
5246	TCT-N 4.5 CHC	Pro TCT-N L4.5mm abutments for restoration for up to 30°	74, 75
5247	TCT-N 5.5 CHC	Pro TCT-N L5.5mm abutments for restoration for up to 30°	74, 75
5248	TCT-N-R	Pro Open Tray Transfer for TCT-N	54, 74, 89

Ref. No.	CODE	PRODUCT DESCRIPTION	PAGE NO.
5252	TCT3.5-N	Pro Tapered Connection Abutment L 3.5mm	54, 55
5253	TCT4.5-N	Pro Tapered Connection Abutment L 4.5mm	54, 55
5254	TCT5.5-N	Pro Tapered Connection Abutment L 5.5mm	54, 55
5280	IA5	Implant Analog D5.0mm	53
5340	TLAW	Wide Straight Titanium Abutment	49
5352	ETLASP1	Simply Esthetic Straight Titanium Abutment H1mm	52
5353	ETLASP2	Simply Esthetic Straight Titanium Abutment H2mm	52
5354	ETLASP3	Simply Esthetic Straight Titanium Abutment H3mm	52
5355	ETLASP4	Simply Esthetic Straight Titanium Abutment H4mm	52
5362	TLAO4	Omni Titanium Abutment Cuff H4.0mm	49
5364	HTLASP	Simply Close Tray Plastic Transfer	48, 52, 88
5366	TLASP1	Simply Straight Titanium Abutment Cuff H1.0mm	48
5367	TLASP2	Simply Straight Titanium Abutment Cuff H2.0mm	48
5368	TLASP3	Simply Straight Titanium Abutment Cuff H3.0mm	48
5369	TLASP4	Simply Straight Titanium Abutment Cuff H4.0mm	48
5403	TLASSP	Slim Titanium Abutment with Short Platform	48
5410	EAAS15	Short Esthetic Anatomic Abutment 15°	52
5411	EAA15	Esthetic Anatomic Abutment 15°	52
5412	EAAH15	High Esthetic Anatomic Abutment 15°	52
5413	EAAS25	Short Esthetic Anatomic Abutment 25°	52
5414	EAA25	Esthetic Anatomic Abutment 25°	52
5415	EAAH25	High Esthetic Anatomic Abutment 25°	52
5416	TPA 1	Straight temporary PEEK Abutment H 1.0	50
5417	TPA 2	Straight temporary PEEK abutment H 2.0	50
5418	TPA 3	Straight temporary PEEK abutment H 3.0	50
5419	TPA15-1	Temporary PEEK abutment 15° H1.0	50
5420	TPA15-2	Temporary PEEK abutment 15° H 2.0	50
5421	TPA15-3	Temporary PEEK abutment 15° H 3.0	50
5422	TPA25-1	Temporary PEEK abutment 25° H 1.0	50
5423	TPA25-2	Temporary PEEK abutment 25° H 2.0	50
5432	AU 17-1.5 HI	Multi Unit Angled abutment 17° 1.5mm for restoration on IH implants	54, 55
5433	AU 17-2.5 HI	Multi Unit Angled abutment 17° 2.5mm for restoration on IH implants	54, 55
5434	AU 17-3.5 HI	Multi Unit Angled abutment 17° 3.5mm for restoration on IH implants	54, 55
5437	AU 30-1.5 HI	Multi Unit Angled abutment 30° 1.5mm for restoration on IH implants	54, 55
5438	AU 30-2.5 HI	Multi Unit Angled abutment 30° 2.5mm for restoration on IH implants	54, 55
5439	AU 30-3.5 HI	Multi Unit Angled abutment 30° 3.5mm for restoration on IH implants	54, 55
6040	HBC0.5	Hex Base Connection L 0.5mm	55
6041	HBC1.5	Hex Base Connection L 1.5mm	55
6042	HBC2.5	Hex Base Connection L 2.5mm	55
6092	SF-N	Fixation Screw SF-N	54,56,74, 76,90,91
6093	SFT-N	Fixation Torqfit Screw SFT-N	54,56,74, 76,90,91
6210	TB2	Titanium Ball Abutment L2.0mm	59
6220	TB4	Titanium Ball Abutment L4.0mm	59
6240	H	Metal Housing for Ball Attachment	59, 79
6250	NC	Standard Nylon Cap	59, 79

Ref. No.	CODE	PRODUCT DESCRIPTION	PAGE NO.
6251	NCT	Nylon Cap with Titanium Ring	59, 79
6253	NCA	Soft Nylon Cap	59, 79
6260	TB0.5	Titanium Ball Abutment L 0.5mm	59
6270	TB5	Titanium Ball Abutment L5.0mm	59
6280	TB3	Titanium Ball Abutment L3.0mm	59
6290	TB6	Titanium Ball Abutment L6.0mm	59
6304	TBAA2	Angled Titanium Side Ball Abutment L2.0mm	59
6306	TBAA3	Angled Titanium Side Ball Abutment L3.0mm	59
6405	TLABCC	Chrome Cobalt Casting Abutment	53
6406	TLABCC-R	Chrome Cobalt Casting Abutment Rotational	53
7301	ITD2.1L-CHC	Implant Driver Long 2.1mm CHC	24
7302	ITD2.1S-CHC	Implant Driver Short 2.1mm CHC	24
7303	IT2.1LM-CHC	Motor Mount Driver Long 2.1mm CHC	24
7304	IT2.1SM-CHC	Motor Mount Driver Short 2.1mm CHC	24
7305	ITD2.1-CHC	Implant Driver Standard 2.1mm CHC	24
7311	HSD3.4-2-CHC	Healing Abutment D3.4 L2 CHC	68
7312	HSD3.4-3-CHC	Healing Abutment D3.4 L3 CHC	68
7313	HSD3.4-5-CHC	Healing Abutment D3.4 L5 CHC	68
7315	HSD3.8-2-CHC	Healing Abutment D3.8 L2 CHC	68
7316	HSD3.8-3-CHC	Healing Abutment D3.8 L3 CHC	68
7317	HSD3.8-5-CHC	Healing Abutment D3.8 L5 CHC	68
7319	HSD4.2-2-CHC	Healing Abutment D4.2 L2 CHC	68
7320	HSD4.2-3-CHC	Healing Abutment D4.2 L3 CHC	68
7321	HSD4.2-5-CHC	Healing Abutment D4.2 L5 CHC	68
7333	HLTS-CHC	Closed Tray Transfer CHC	69
7335	HLTO-CHC	Long Open Tray Transfer CHC	69
7338	IA-CHC	Implant Analog CHC	69
7345	STLA-CHC	Abutment Screw CHC	72
7350	ETLASP1-CHC	Esthetic Simply Straight Abutment H1.0mm CHC	70
7351	ETLASP2-CHC	Esthetic Simply Straight Abutment H2.0mm CHC	70
7352	ETLASP3-CHC	Esthetic Simply Straight Abutment H3.0mm CHC	70
7353	ETLASP4-CHC	Esthetic Simply Straight Abutment H4.0mm CHC	70
7356	ETLAS3.2-CHC	Esthetic Standard Slim Abutment D3.2 CHC	70
7357	ETLAS3.6-CHC	Esthetic Standard Abutment D3.6 CHC	70
7358	TLAS4.0-CHC	Standard Abutment D4.0 CHC	70
7360	ETLA15-CHC	Esthetic Angled Titanium Abutment 15° CHC	71
7361	ETLAL15-CHC	Esthetic Angled Long Titanium Abutment 15° CHC	71
7362	ETLA25-CHC	Esthetic Angled Titanium Abutment 25° CHC	71
7363	EA15-1.5-CHC	Esthetic Anatomic 15° Angled Titanium Abutment H1.5mm CHC	71
7364	EA15-2.5-CHC	Esthetic Anatomic 15° Angled Titanium Abutment H2.5mm CHC	71
7365	EA15-3.5-CHC	Esthetic Anatomic 15° Angled Titanium Abutment H3.5mm CHC	71
7366	EA25-1.5-CHC	Esthetic Anatomic 25° Angled Titanium Abutment H1.5mm CHC	71
7367	EA25-2.5-CHC	Esthetic Anatomic 25° Angled Titanium Abutment H2.5mm CHC	71
7368	EA25-3.5-CHC	Esthetic Anatomic 25° Angled Titanium Abutment H3.5mm CHC	71
7370	ETWASP1-CHC	Esthetic Simply Straight Wide Abutments H1.0mm CHC	70

Ref. No.	CODE	PRODUCT DESCRIPTION	PAGE NO.
7371	ETWASP2-CHC	Esthetic Simply Straight Wide Abutments H2.0mm CHC	70
7372	ETWASP3-CHC	Esthetic Simply Straight Wide Abutments H3.0mm CHC	70
7373	ETWASP4-CHC	Esthetic Simply Straight Wide Abutments H4.0mm CHC	70
7374	ETWASP5-CHC	Esthetic Simply Straight Wide Abutments H5.0mm CHC	70
7383	ETLAS4.0-CHC	Esthetic Standard Abutment D4.0 CHC	70
7400	RS-CHC	Retrieval Screw CHC	72
7403	TB1-CHC	Titanium Ball Abutment 2.5mm L 1mm CHC	79
7404	TB2-CHC	Titanium Ball Abutment 2.5mm L 2mm CHC	79
7405	TB3-CHC	Titanium Ball Abutment 2.5mm L 3mm CHC	79
7406	TB4-CHC	Titanium Ball Abutment 2.5mm L 4mm CHC	79
7407	TB5-CHC	Titanium Ball Abutment 2.5mm L 5mm CHC	79
7470	AK0.5-CHC	AlphaLoC Kit 0.5mm for restoration on CHC implants	78
7471	AK1-CHC	AlphaLoC Kit 1mm for restoration on CHC implants	78
7472	AK2-CHC	AlphaLoC Kit 2mm for restoration on CHC implants	78
7473	AK3-CHC	AlphaLoC Kit 3mm for restoration on CHC implants	78
7474	AK4-CHC	AlphaLoC Kit 4mm for restoration on CHC implants	78
7475	AK5-CHC	AlphaLoC Kit 5mm for restoration on CHC implants	78
7482	AU 17-1.5 CHC	Multi Unit Angled abutment 17° 1.5mm for restoration on CHC implants	74, 75
7483	AU 17-2.5 CHC	Multi Unit Angled abutment 17° 2.5mm for restoration on CHC implants	74, 75
7484	AU 17-3.5 CHC	Multi Unit Angled abutment 17° 3.5mm for restoration on CHC implants	74, 75
7487	AU 30-1.5 CHC	Multi Unit Angled abutment 30° 1.5mm for restoration on CHC implants	74, 75
7488	AU 30-2.5 CHC	Multi Unit Angled abutment 30° 2.5mm for restoration on CHC implants	74, 75
7489	AU 30-3.5 CHC	Multi Unit Angled abutment 30° 3.5mm for restoration on CHC implants	74, 75
65003	TPS	Tissue Punch Small	97
65004	TPL	Tissue Punch Large	97
65005	CDS	Crestal Drill Small	97
65006	CDL	Crestal Drill Large	97
65007	CD2-8	Surgical Drill D2.0mm – L8mm	97
65008	CD2-10	Surgical Drill D2.0mm – L10mm	97
65009	CD2-11.5	Surgical Drill D2.0mm – L11.5mm	97
65010	CD2-13	Surgical Drill D2.0mm – L13mm	97
65011	CD2-16	Surgical Drill D2.0mm – L16mm	97
65012	CD2.8-8	Surgical Drill D2.8mm – L8mm	97
65013	CD2.8-10	Surgical Drill D2.8mm – L10mm	97
65014	CD2.8-11.5	Surgical Drill D2.8mm – L11.5mm	97
65015	CD2.8-13	Surgical Drill D2.8mm – L13mm	97
65016	CD2.8-16	Surgical Drill D2.8mm – L16mm	97
65017	CD3.2-8	Surgical Drill D3.2mm – L8mm	97
65018	CD3.2-10	Surgical Drill D3.2mm – L10mm	97
65019	CD3.2-11.5	Surgical Drill D3.2mm – L11.5mm	97
65020	CD3.2-13	Surgical Drill D3.2mm – L13mm	97
65021	CD3.2-16	Surgical Drill D3.2mm – L16mm	97
65022	CD3.6-8	Surgical Drill D3.6mm – L8mm	97
65023	CD3.6-10	Surgical Drill D3.6mm – L10mm	97
65024	CD3.6-11.5	Surgical Drill D3.6mm – L11.5mm	97
65025	CD3.6-13	Surgical Drill D3.6mm – L13mm	97

Ref. No.	CODE	PRODUCT DESCRIPTION	PAGE NO.
65026	CD3.6-16	Surgical Drill D3.6mm - L16mm	97
65027	CD4.1-8	Surgical Drill D4.1mm - L8mm	97
65028	CD4.1-10	Surgical Drill D4.1mm - L10mm	97
65029	CD4.1-11.5	Surgical Drill D4.1mm - L11.5mm	97
65030	CD4.1-13	Surgical Drill D4.1mm - L13mm	97
65031	CD4.1-16	Surgical Drill D4.1mm - L16mm	97
65032	CD4.5-8	Surgical Drill D4.5mm - L8mm	97
65033	CD4.5-10	Surgical Drill D4.5mm - L10mm	97
65034	CD4.5-11.5	Surgical Drill D4.5mm - L11.5mm	97
65035	CD4.5-13	Surgical Drill D4.5mm - L13mm	97
65036	CD4.5-16	Surgical Drill D4.5mm - L16mm	97
65037	IMS	Implant Mount Small	97
65038	IML	Implant Mount Large	97
65039	IMHS	Implant Mount Screw	97
65042	IMX	Implant mount extention	97
65044	HIA	Handpiece Insertion Adapter	97
65045	IME	Implant Mount Extractor	97
65047	LP	Lateral Pin	97
65048	CPS	Crestal Pin Small	97
65049	CPL	Crestal Pin Large	97
65050	MCD1.5	Milling Drill D1.5mm	97
65055	IMC	Implant Mount CHC	97
65056	IMCS	Implant Mount Screw CHC	97
65057	SAD	Sleeve L/S Adaptor Driver	97
65058	SLSA	Sleeve Adaptor 4.1	97
65058	SLSA	Small Sleeve for Adaptor	97
65061	IMCD	Implant Mount CHC Driver	97
65062	IMSD	Implant Mount Int. Hex Driver Small	97
65063	IMLD	Implant Mount Int. Hex Driver Large	97
65064	IMSS	Implant Mount CS Small	97
65065	IMSL	Implant Mount CS large	97
65070	CD2.4-8	Surgical Drill D2.4mm - L8mm	97
65071	CD2.4-10	Surgical Drill D2.4mm - L10mm	97
65072	CD2.4-11.5	Surgical Drill D2.4mm - L11.5mm	97
65073	CD2.4-13	Surgical Drill D2.4mm - L13mm	97
65074	CD2.4-16	Surgical Drill D2.4mm - L16mm	97
66012	SLS	Master Sleeve 4.1 for drilling and implant insertion	96
66012	SLS	Small Sleeve for surgical guide	96
66013	SLL	Master Sleeve 5.5 for drilling and implant insertion	96
66013	SLL	Large Sleeve for surgical guide	96
66014	SLSE	Master Sleeve to support lateral pin	96
66014	SLSE	Securing Sleeve for surgical guide	96
KIT # 65000	GSTK	GSTK kit for IH and CHC	18,96
KIT # 65002	GSTK	GSTK kit for CS and CHC	18,96
KIT # 65003	GSTK	GSTK kit for CS, CHC and IH	18,96



OUR WARRANTY - YOUR PEACE OF MIND

Alpha-Bio Tec's high quality products meet strict international standards.

This is why we can provide you with a Lifetime Warranty for our wide range of implants (not including provisional implants). In any case of a defect in the implant, implant rejection, fracture or contamination of the product, subject to filing a complaint report, Alpha-Bio Tec shall replace the defective merchandise.

Warranty: Alpha-Bio Tec warrants that all Implants will be free of defects in materials and/or workmanship. This warranty applies to the original purchaser only. There are no warranties, express or implied, except this warranty, which is given in lieu of any other warranties, express or implied, including any implied warranty of fitness for a particular purpose.

Important - Read instructions before use.

A complaint report is available at Alpha-Bio Tec's customer service and will be sent upon demand.

Alpha-Bio Tec Warranty

Alpha-Bio Tec continually strives to update and improve its products; hence we reserve the right to modify designs, products and/or techniques when we feel it is warranted. We also reserve the right to change prices, policies and terms without prior notice. Product availability may vary between countries. Some products may not be available in the USA.

Warranty: Alpha-Bio Tec makes no warranty, expressed or implied, except that all products will be free of defects in materials and/or workmanship. This warranty applies to the original purchaser. In the event of a product defect, please notify Alpha-Bio Tec in writing prior to returning the product.

Alpha-Bio Tec will then, at its discretion, repair, replace or issue a credit for defective merchandise.

The purchaser assumes all risk and liabilities from the use of these products, whether used separately or in conjunction with products not of Alpha-Bio Tec's manufacture.

Alpha-Bio Tec strongly recommends completion of post-graduate implant education and adherence to all technical procedures and instructions. Federal law permits the sale of these products to licensed physicians and dental practitioners only. Products in this catalog may be protected by more than one patent.

Copyright © Alpha-Bio Tec Ltd. All rights reserved. Important - Read instructions before use.



Implantology, In Everything We Do

Alpha-Bio Tec's products are cleared for marketing in the USA and are CE-marked in accordance with the Council Directive 93/42/EEC. Alpha-Bio Tec's complies with EN ISO 13485:2016. Product availability may vary between countries.

www.alpha-bio.net

